

WALCHEM

IWAKI America Inc.

WDB400 Dual Boiler Controller

WDB400 Series Dual Boiler Controller Instruction Manual

Notice

© 2014 WALCHEM, Iwaki America Inc. (hereinafter "Walchem")
5 Boynton Road, Holliston, MA 01746 USA
(508) 429-1110
All Rights Reserved
Printed in USA

Proprietary Material

The information and descriptions contained herein are the property of WALCHEM. Such information and descriptions may not be copied or reproduced by any means, or disseminated or distributed without the express prior written permission of WALCHEM, 5 Boynton Road, Holliston, MA 01746.

This document is for information purposes only and is subject to change without notice.

Statement of Limited Warranty

WALCHEM warrants equipment of its manufacture, and bearing its identification to be free from defects in workmanship and material for a period of 24 months for electronics and 12 months for mechanical parts and electrodes from date of delivery from the factory or authorized distributor under normal use and service and otherwise when such equipment is used in accordance with instructions furnished by WALCHEM and for the purposes disclosed in writing at the time of purchase, if any. WALCHEM's liability under this warranty shall be limited to replacement or repair, F.O.B. Holliston, MA U.S.A. of any defective equipment or part which, having been returned to WALCHEM, transportation charges prepaid, has been inspected and determined by WALCHEM to be defective. Replaceable elastomeric parts and glass components are expendable and are not covered by any warranty.

THIS WARRANTY IS IN LIEU OF ANY OTHER WARRANTY, EITHER EXPRESS OR IMPLIED, AS TO DESCRIPTION, QUALITY, MERCHANTABILITY, FITNESS FOR ANY PARTICULAR PURPOSE OR USE, OR ANY OTHER MATTER.

180328.L
April 2014

Table of Contents

1.0	INTRODUCTION.....	1
2.0	SPECIFICATIONS	2
2.1	Measurement Performance	2
2.2	Electrical: Input/Output	2
2.3	Mechanical	2
2.4	WDB Variables and their Limits.....	3
3.0	UNPACKING & INSTALLATION.....	4
3.1	Unpacking the unit.....	4
3.2	Mounting the electronic enclosure.....	4
3.3	Installation	4
3.4	Icon Definitions.....	8
3.5	Electrical installation	8
4.0	FUNCTION OVERVIEW	12
4.1	Front Panel.....	12
4.2	Display.....	12
4.3	Keypad	13
4.4	Access Code	13
4.5	Startup.....	13
4.6	Shut Down	13
5.0	OPERATION	14
5.1	Main Menu.....	14
5.2	Conductivity (A or B) Menu.....	16
5.3	Temperature (A or B) Menu.....	19
5.4	Blowdown (A or B) Menu.....	20
5.5	Auxiliary Menu	22
5.6	WM1 and WM2 Menu.....	25
5.7	Time Menu.....	26
5.8	4-20mA (A or B) Menu.....	27
5.9	Access Code Menu	28
5.10	Datalog Menu.....	29
5.11	Config Menu.....	31
5.12	Upgrade Menu	32
6.0	MAINTENANCE	33
6.1	Electrode Cleaning	33
6.2	Replacing the Fuses.....	33
7.0	TROUBLESHOOTING	34
7.1	Error Messages	34
7.2	Conductivity Readout Does Not Change.....	36
7.3	Procedure for Evaluation of Conductivity Electrode	36
7.4	Procedure for Checking Relay Outputs.....	36
7.5	No Display	37
8.0	SERVICE POLICY	37

1.0 INTRODUCTION

The Walchem WDB400 Series controllers offer conductivity control of boiler water and control of chemical feed of two separate boilers. The chemical feed pump may be selected to operate in one of the following modes:

- Feed and Blowdown
- Feed and Blowdown with Lockout
- Feed as a percent of Blowdown
- Feed as a percent of Time
- Feed based on a Water Contactor input
- Feed based on a Paddlewheel

The WDB series boiler controller is supplied with temperature compensated stainless steel electrodes with a cell constant of 1.0. The controller is a microprocessor driven industrial type with on/off control outputs. Timed intermittent sample or continuous modes may be selected. One or two optional 4-20 mA outputs that are proportional to the conductivity reading are available for all models.

Any set point may be viewed without interrupting control. Each set point change will take effect as soon as it is entered. An access code is available to protect set point parameters, while still allowing settings to be viewed.

An alarm relay is provided that is triggered by:

- Low conductivity reading
- High conductivity reading
- No flow situation
- Sensor error
- Temperature sensor error
- Blowdown timeout

Our unique USB feature provides the ability to upgrade the software in the controller to the latest version.

An advanced USB capability option is available. The Config file feature allows you to save all the set points from a controller onto a USB flash disk, and then import them into another controller, making the programming of multiple controllers fast and easy. The data logging feature allows you to save the last months readings and events to a USB flash disk.

2.0 SPECIFICATIONS

2.1 Measurement Performance

Conductivity Range	0 - 10,000 $\mu\text{S}/\text{cm}$ (microSiemens/centimeter)
Conductivity Resolution	1 $\mu\text{S}/\text{cm}$
Conductivity Accuracy	10 - 10,000 $\mu\text{S}/\text{cm}$ $\pm 1\%$ of reading 0 - 10 $\mu\text{S}/\text{cm}$ $\pm 20\%$ of reading
Temperature Range	32 - 401°F (0 - 205°C)
Temperature Resolution	0.1°C
Temperature Accuracy	$\pm 1\%$ of reading

2.2 Electrical: Input/Output

Input Power	100-240 VAC, 50/60 Hz, 8A Fuse: 1.0 ampere, 5 x 20 mm
Input Signals	
Conductivity electrode	1.0 cell constant, Pt1000 RTD
Flow Meter (optional)	Isolated, dry contact closure required (i.e. relay,reed switch)
Flow Switch (optional)	Isolated, dry contact closure required (i.e. reed switch)
Outputs	
Mechanical Relays	Pre-powered on circuit board switching line voltage 6 A (resistive), 1/8 HP All relays are fused together as one group, total current for this group must not exceed 6A.
4 - 20 mA (1 or 2 optional)	Internally powered Fully isolated 600 Ohm max resistive load Resolution .001% of span Accuracy $\pm 1\%$ of reading
Agency Approvals	
Safety	UL 61010-1:2012 3rd Ed. CSA C22.2 No. 61010-1:2012 3rd Ed. IEC 61010-1:2010 3rd Ed. EN 61010-1:2010 3rd Ed.
EMC	IEC 61326-1:2005 EN 61326-1:2006

Note: For EN61000-4-6, EN61000-4-3 the controller met performance criteria B.

*Class A equipment: Equipment suitable for use in establishments other than domestic, and those directly connected to a low voltage (100-240 VAC) power supply network which supplies buildings used for domestic purposes.

2.3 Mechanical

Enclosure Material	Polycarbonate
NEMA Rating	NEMA 4X
Dimensions	8.5" x 6.5" x 5.5"
Display	2 x 16 character backlit liquid crystal
Operating Ambient Temp	32 – 122°F (0 – 50°C)
Storage Temperature	-20 – 180°F (-29 – 80°C)
Electrode mounting	$\frac{3}{4}$ " NPTF
Electrode rating	250 psi at 401°F (17.2 bars at 205°C)
Electrode material	316 SS and PEEK

2.4 WDB Variables and their Limits

		Low Limit	High Limit
Conductivity menu			
	PPM Conversion Factor	0.200 ppm/ μ S/cm	1.000 ppm/ μ S/cm
	Interval Time (sampling)	5 minutes	24:00 hours
	Duration Time (sampling)	1 minute	59 min: 59 sec
	Hold Time	1 second	499 min: 59 sec
	Blowdown Time	1 minute	8 hrs: 20 min
	Max Proportional Time	1 minute	8 hrs: 20 min
	Proportional Band	0	10,000 μ S/cm
	% Calibration Range	-50%	+50%
Temperature Menu			
		No variables	
Blowdown Menu			
	Set Point	0 μ S/cm	10,000 μ S/cm
	Dead Band	5 μ S/cm	500 μ S/cm
	Blowdown Limit Time (set in hours/minutes)	1 minute	8 hrs: 20 min (enabled) 0=unlimited (disabled)
Feed Menu			
	Feed Lockout Timer (Mode A)	1 second	99 min: 59 sec
	Percent of Blowdown (Mode B)	5 %	99 %
	Feed Time Limit (Mode B)	1 minute	99 min: 59 sec
	Percent of Time (Mode C)	5 %	99 %
	Feed Cycle Time (Mode C)	10 minutes	59 min: 59 sec
	Time per Contact (Mode D)	1 second	59 min: 59 sec
	÷ Contacts by (Mode D)	1 contact	100 contacts
	Time Limit (Mode D & E)	1 minute	99 min: 59 sec
	Time/Vol (Mode E)	1 second	59 min: 59 sec
	Vol to Initiate Feed (Mode E)	1	9,999
WM1 and WM2 Menus			
	Gallons per Contact	1 gal/contact	500 gal/contact
	Liters per Contact	1 L/contact	500 L/contact
	K Factor (Paddlewheel)	0.01 pulse/vol	999.99 pulses/vol
4-20 mA 1 and 2 Menus			
	4 & 20 mA Settings	0 μ S/cm	10,000 μ S/cm
Access Code Menu			
	New Value	0	9999
Alarm Menu*			
	High & Low (set to zero to disable)	1%	50%
Datalog Menu (Optional)			
		No variables	
Config Menu (Optional)			
		No variables	
Upgrade Menu			
		No variables	

*Note: The Alarm relay is non-programmable. Refer to the Main Menu diagram on page 16 for the list of error conditions that trigger the alarm relay.

3.0 UNPACKING & INSTALLATION

3.1 Unpacking the unit

Inspect the contents of the carton. Please notify the carrier immediately if there are any signs of damage to the controller or its parts. Contact your distributor if any of the parts are missing. The carton should contain: a WDB series controller and instruction manual. Any options or accessories will be incorporated as ordered.

3.2 Mounting the electronic enclosure

The WDB series controller is supplied with mounting holes on the enclosure. It should be wall mounted with the display at eye level, on a vibration-free surface, utilizing all four mounting holes for maximum stability. Use M6 (1/4" diameter) fasteners that are appropriate for the substrate material of the wall. The enclosure is NEMA 4X rated. The maximum operating ambient temperature is 122°F (50°C); this should be considered if installation is in a high temperature location. The enclosure requires the following clearances:

Top:	2" (50 mm)
Left:	8" (203 mm)
Right:	4" (102 mm)
Bottom:	7" (178 mm)

3.3 Installation

Once the WDB series controller is mounted, the metering pumps may be located at any distance from the controller. The conductivity electrodes should be placed as close to the controller as possible, to a maximum distance of 250 ft. Less than 25 ft is recommended. The cable **MUST** be shielded from background electrical noise. (The standard cable length is 10 feet. Should you require longer cable, consult factory.)

Important Installation Notes: (see figure 1)

- 1. Make sure the minimum water level in the boiler is at least 4-6 inches above the skimmer blowdown line. If the skimmer line is closer to the surface, it is likely that steam will be drawn into the line instead of boiler water. The skimmer line must also be installed above the highest tube.**
- 2. Maintain a 3/4 inch minimum pipe ID with no flow restrictions from the tap for the boiler skimmer blowdown line to the electrode. If the ID is reduced below 3/4 inch, then flashing will occur beyond that point and the conductivity reading will be low and erratic. Minimize the usage of tees, valves, elbows or unions between the boiler and the electrode.**
- 3. A manual shut off valve should be installed so that the electrode can be removed and cleaned. This valve must be a full port valve in order to avoid a flow restriction.**
- 4. Keep the distance between the tap for the boiler skimmer line to the electrode as short as possible, to a maximum of 10 feet.**
- 5. Mount the electrode in the side branch of a cross in a horizontal run of pipe. This will minimize entrapment of steam around the electrode and will allow any solids to pass through.**

6. There **MUST** be a flow restriction after the electrode and/or control valve in order to provide back pressure. This flow restriction will be either a flow control valve or an orifice union. The amount of the flow restriction will affect the blowdown rate as well, and should be sized accordingly.
7. Install the motorized ball valve or solenoid valve per the manufacturer's instructions.
8. For best results, align the hole in the conductivity electrode such that the direction of water flow is through the hole.

Guide to Sizing Blowdown Valves and Orifice Plates

1. Determine the Rate of Steam Production in Pounds per Hour

Either read off the boiler name plate (water-tube boilers) or
Calculate from horsepower rating (fire-tube boilers):

HP x 34.5 = lbs/hr. Example: 100 HP = 3450 lbs/hr.

2. Determine the Concentration Ratio (BASED ON FEEDWATER)

A water treatment chemical specialist should determine the desired number of cycles of concentration. This is the ratio of TDS in the boiler water to TDS in the feedwater. Note that feedwater means the water that is fed to the boiler from the deaerator and includes makeup water plus condensate return.

Example: 10 cycles of concentration has been recommended

3. Determine the Required Blowdown Rate in Pounds Per Hour

Blowdown Rate = Steam Production / (Concentration Ratio -1)

Example: $3450 / (10 - 1) = 383.33$ lbs./hr

4. Determine if Continuous or Intermittent Sampling is Required

Use intermittent sampling when the boiler operation or loading is intermittent, or on boilers where the required blowdown rate is less than 25% of the smallest available flow control valve or less than the flow through the smallest orifice. See the charts below.

Use continuous sampling when the boiler is operating 24 hours per day and the required blowdown rate is more than 25% of the smallest applicable flow control valve or orifice. See the charts below.

Use of a flow control valve will give you the best control of the process, since the flow rate can be easily adjusted. The dial on the valve also gives you a visual indication if the flow rate has been changed. If the valve clogs, it can be opened to clear the obstruction, and closed to the previous position.

If an orifice plate is used, you must install a valve downstream from the orifice in order to fine tune the flow rate and provide additional back pressure in many applications.

Example: An 80 psi boiler has a Required Blowdown Rate of 383.33 lbs./hr. The maximum flow rate of the smallest flow control valve is 3250 lbs./hr. $3250 \times 0.25 = 812.5$ which is too high for continuous sampling. Using an orifice, the flow rate through the smallest diameter plate is 1275 lbs./hr. This is too high for continuous sampling.

5. Determine the Orifice or Flow Control Valve Size for this Blowdown Rate

Use the following graphs to select a flow control device:

Flow Rate in Lbs/hr for Various Orifices

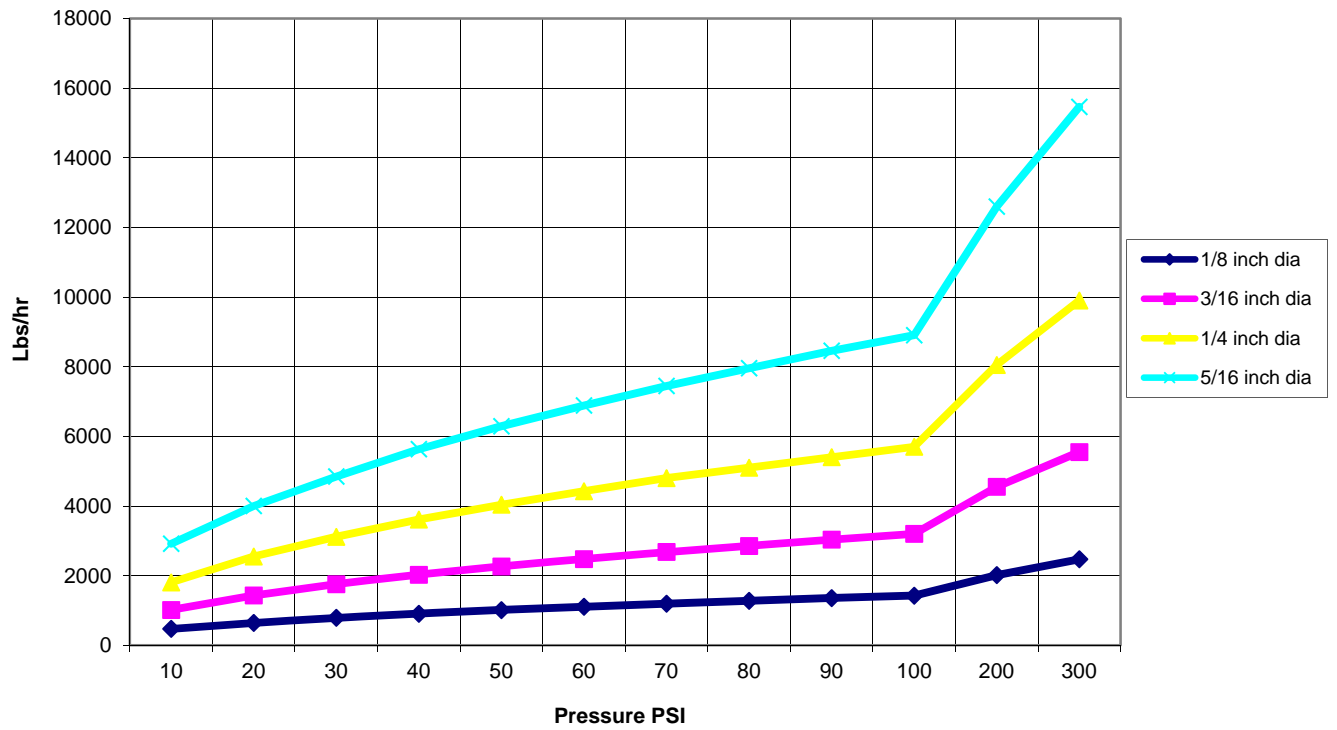

Flow Control Valve
Maximum Flow Rates in Lbs/hr

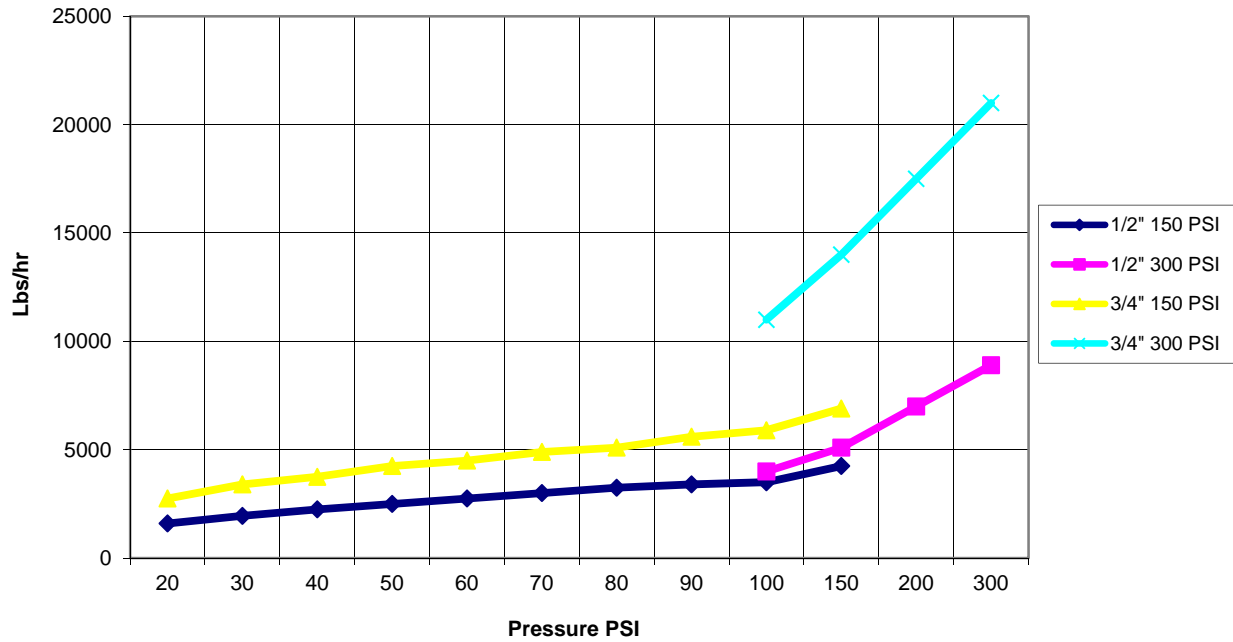

FIGURE 1
RECOMMENDED INSTALLATION
INTERMITTENT SAMPLING

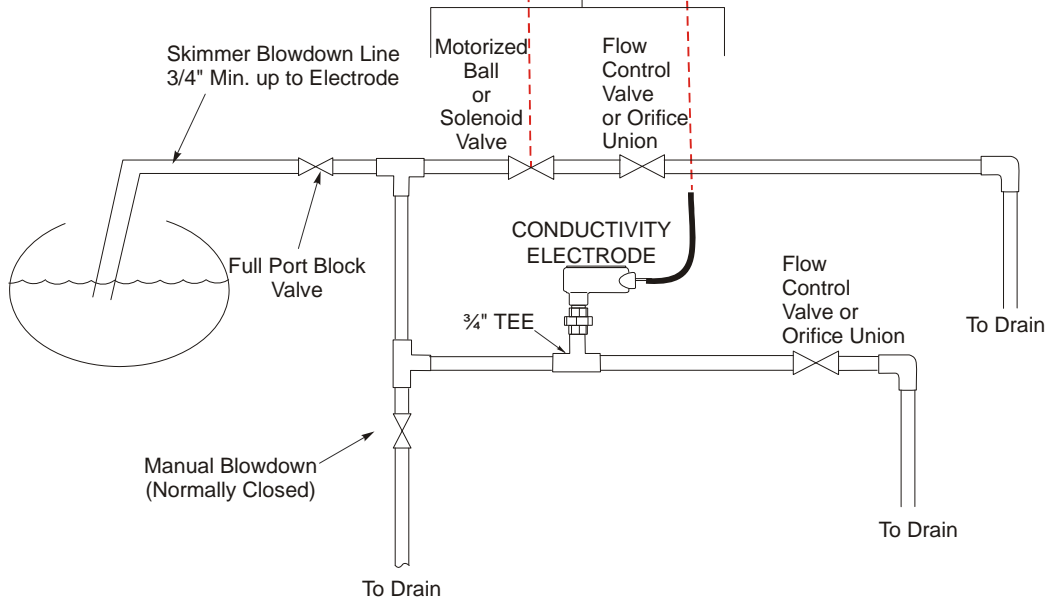
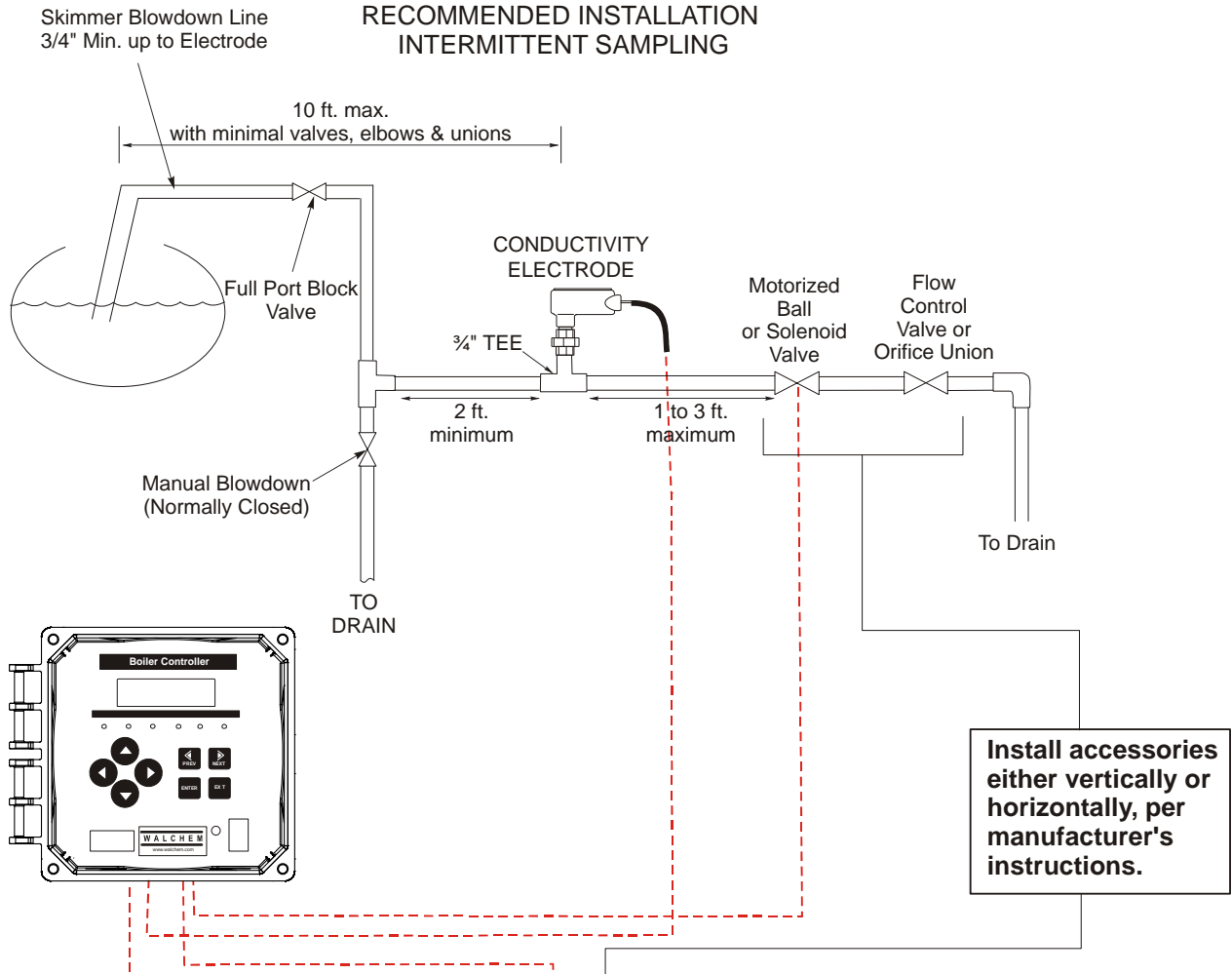







FIGURE 2
RECOMMENDED INSTALLATION
CONTINUOUS SAMPLING

3.4 Icon Definitions



Symbol	Publication	Description
	IEC 417, No.5019	Protective Conductor Terminal
	IEC 417, No. 5007	On (Supply)
	IEC 417, No. 5008	Off (Supply)
	ISO 3864, No. B.3.6	Caution, risk of electric shock
	ISO 3864, No. B.3.1	Caution

3.5 Electrical installation

The various standard wiring options are shown in figure 3, below. Your WDB series controller will arrive from the factory prewired or ready for hardwiring. Depending on your configuration of controller options, you may be required to hardwire some or all of the input/output devices. Refer to figures 4 and 5 for circuit board layout and wiring.

Notes:

1. When wiring the conductivity electrode, it is critical to use shielded 24 AWG cable. **DO NOT** route the cable in the same conduit as any AC wiring. The shield must be terminated at the controller earth ground only. Make sure to cut off the shield wire at the electrode and to ensure that it does not touch the grounded junction box.
2. When wiring the optional flow meter contactor input, the 4-20 mA output or a remote flow switch, it is advisable to use stranded, shielded, twisted pair wire between 22-26 AWG. Shield should be terminated at the controller ground stud (see figures 4 and 5).
3. Always route low voltage (sensor) signals with at least 6" separation from AC voltage wiring.

	<h2>CAUTION</h2>	
<ol style="list-style-type: none"> 1. There are live circuits inside the controller even when the power switch on the front panel is in the OFF position! The front panel must never be opened before power to the controller is REMOVED! If your controller is prewired, it is supplied with a 8 foot, 18 AWG power cord with USA style plug. A tool (#1 Phillips driver) is required to open the front panel. 2. When mounting the controller, make sure there is clear access to the disconnecting device! 3. The electrical installation of the controller must be done by trained personnel only and conform to all applicable National, State and Local codes! 4. Proper grounding of this product is required. Any attempt to bypass the grounding will compromise the safety of persons and property. 5. Operating this product in a manner not specified by Walchem may impair the protection provided by the equipment. 		

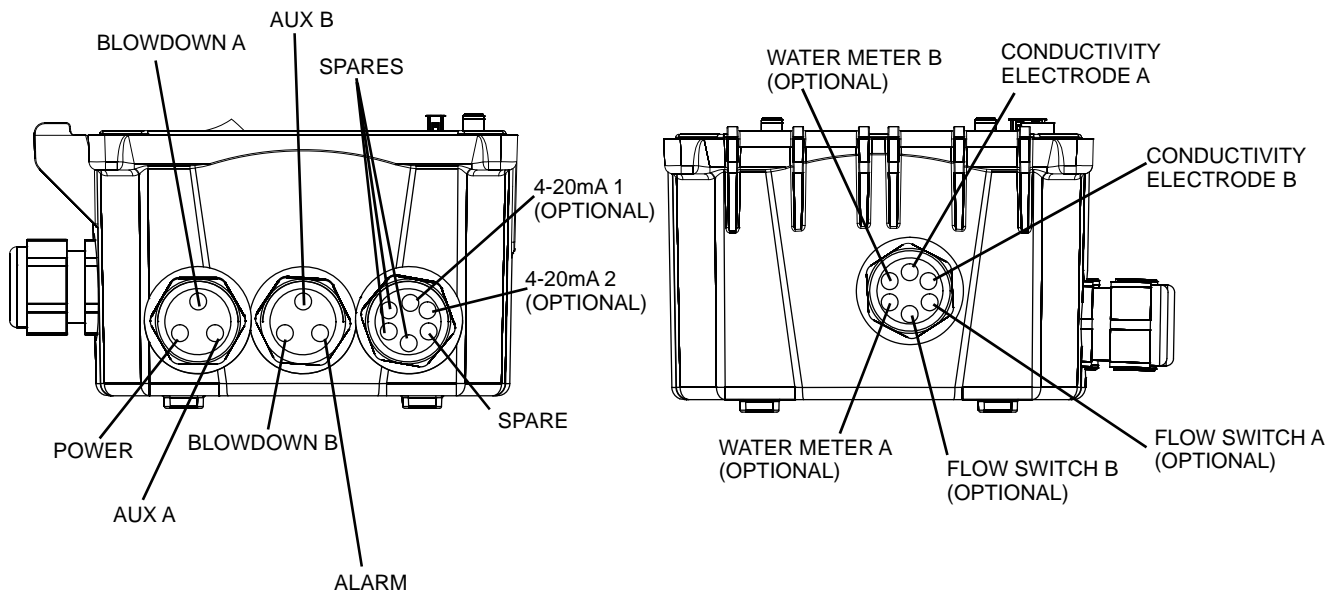

Figure 3 Conduit/Wiring Configuration

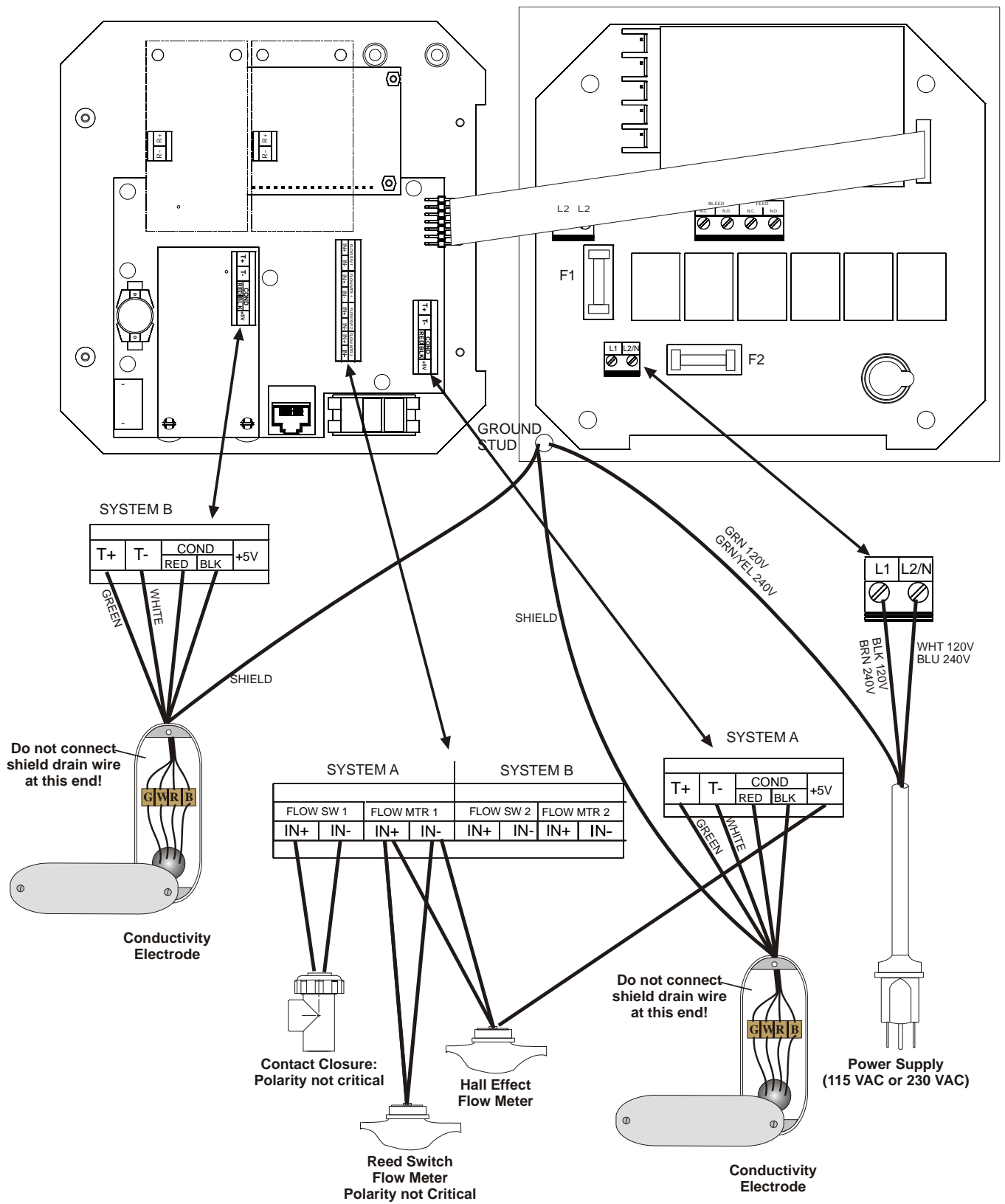

Figure 4 Inputs

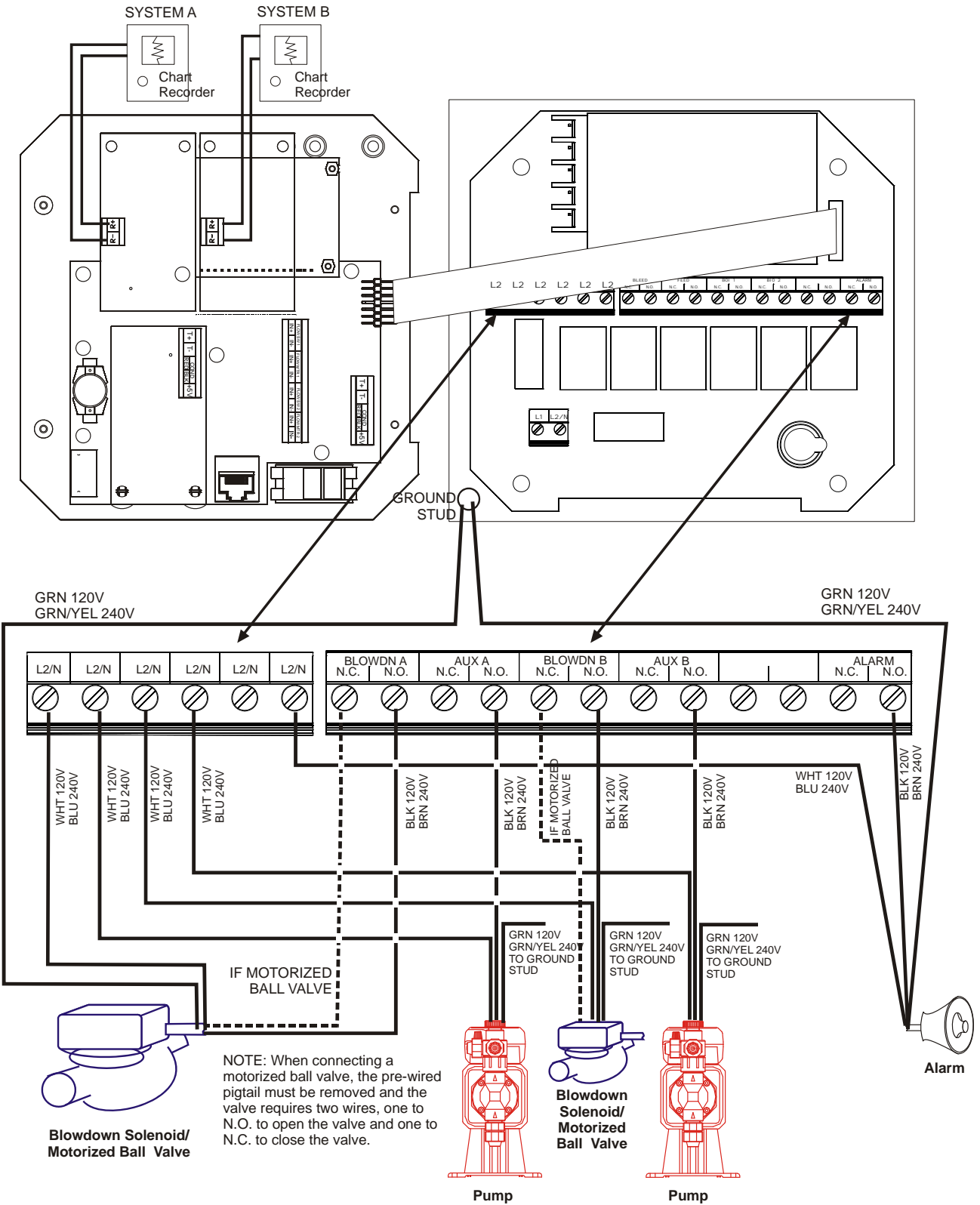

Figure 5 Outputs

4.0 FUNCTION OVERVIEW

4.1 Front Panel

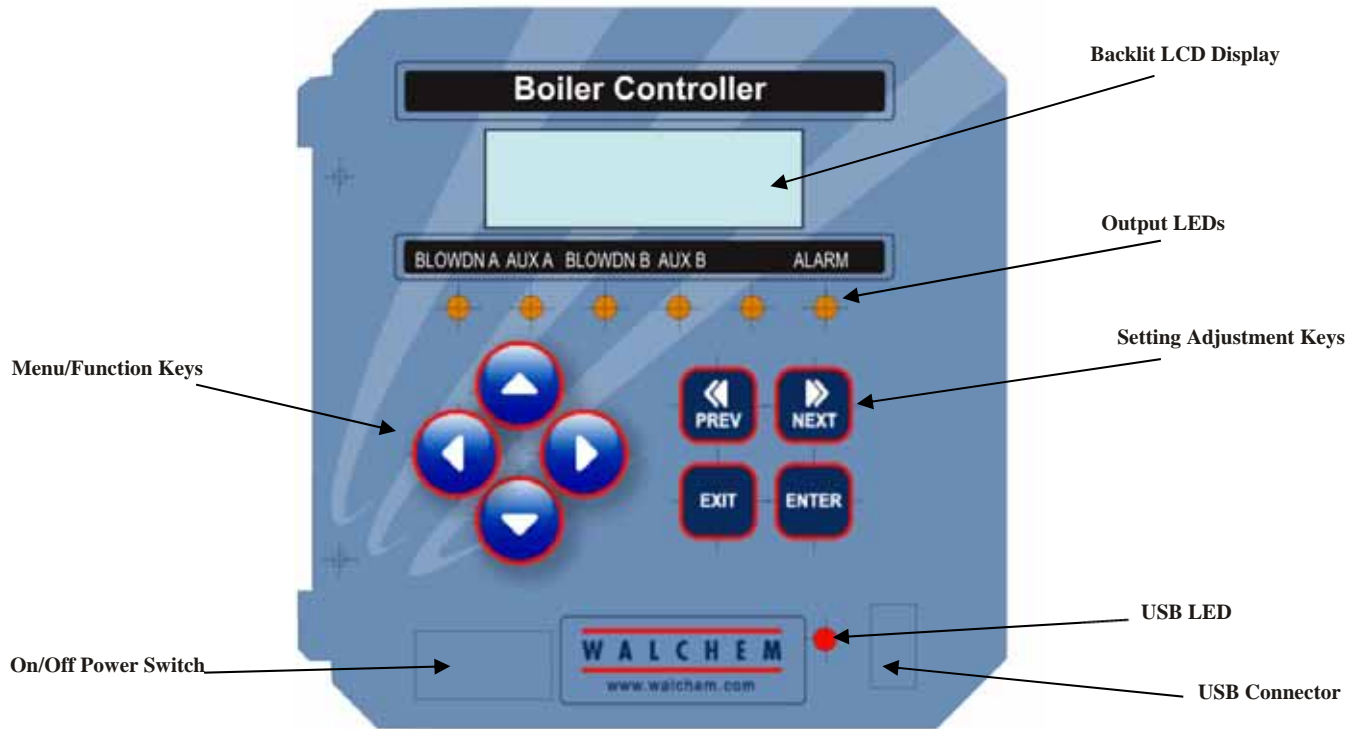

Figure 6 Front Panel

4.2 Display

A summary screen is displayed while the WDB controller is on. The operating conditions that are displayed on the bottom line of this display are Hi Alarm A, Hi Alarm B, Low Alarm A, Low Alarm B, Temp Err A, Temp Err B, Cond Err A, Cond Err B, No Flow A, No Flow B, Blowdown Timeout A, Blowdown Timeout B, Blowdown A, Blowdown B, Feed A Timeout, Feed B Timeout, Feed A, Feed B, Waiting A/B, Sample A/B, Holding A/B, and Normal. Normal just means there is nothing unusual to report.

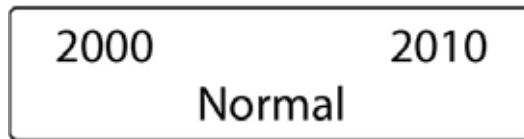

Figure 7 Summary Screen

4.3 Keypad

The keypad consists of 4 directional arrow keys and 4 function keys. The arrows are used to move the adjustment cursor and change settings, while the function keys are used to enter values, and navigate the various menu screens. The function keys are **ENTER**, **EXIT**, **NEXT**, and **PREV** (previous). **NEXT** and **PREV** scroll through the various menu choices. **ENTER** is used to enter a submenu and to enter a value. **EXIT** is used to back up one menu level. If you are at the main menu level, **EXIT** will return you to the Summary Display.



To change a value in a submenu, the left/right arrow keys move the cursor left and right to each digit or option that can be changed. The up/down arrows will change numeric values up or down, or scroll through option choices. Press **ENTER** only when you have finished making all of the changes for that menu screen.

4.4 Access Code

The WDB series controller is shipped with the access code disabled. If you wish to enable it, see Section 5.7 for operation. With the access code enabled, any user can view parameter settings, but not change them. Note that this provides protection only against casual tampering. Use a lock on the cover latch if you need more protection.

4.5 Startup

Initial Startup

After having mounted the enclosure and wired the unit, the controller is ready to be started.

Plug in the controller and turn on the power switch to supply power to the unit. The display will briefly show the WDB model number and then revert to the normal summary display. Scroll through the menus and calibrate the conductivity reading, temperature, and set the control parameters detailed in Section 5, Operation.

To return to the summary display, press the **EXIT** key until you return to this screen. The controller will automatically return to this screen after 10 minutes.

Normal Startup

Startup is a simple process once your set points are in memory. Simply check your supply of chemicals, turn on the controller, calibrate it if necessary and it will start controlling.

4.6 Shut Down

To shut the WDB controller down, simply turn off the power. Programming remains in memory.

5.0 OPERATION

These units control continuously while power is applied. Programming is accomplished via the local keypad and display.

To view the top level menu, press any key. The menu structure is grouped by inputs and outputs. Each input has its own menu for calibration and unit selection as needed. Each output has its own setup menu including set points, timer values and operating modes as needed. After ten minutes of inactivity in the menu, the display will return to the summary display. Keep in mind that even while browsing through menus, the unit is still controlling.

5.1 Main Menu

The exact configuration of your WDB controller determines which menus are available as you scroll through the settings. Certain menus are only available if you select certain options.

Main Menu Top Level

Boiler A	
Boiler B	
Time	
Access Code	
Datalog	Only if advanced USB feature is in model code
Config	Only if advanced USB feature is in model code
Upgrade	

Inside Boiler A and B menus

Conductivity A or B	
Temperature A or B	
Blowdown A or B	
Auxiliary A or B	
WM1 or WM2	Only if the Aux relay is set to Feed on Water contactor or Paddlewheel
4-20mA A or B	Only if 4-20mA option board(s) installed.

The **NEXT** key travels forward through this list while the **PREV** key travels backwards through the list. Pressing **ENTER** will Enter the lower level menu that is currently displayed.

Each of the following menu descriptions is used exactly the same way for either Boiler A or Boiler B.

- Possible status screens
- * HI ALARM A
 - * HI ALARM B
 - * LOW ALARMA
 - * LOW ALARMB
 - * TEMP ERR A
 - * TEMP ERR B
 - * COND. ERR A
 - * COND. ERR B
 - * NO FLOW A
 - * NO FLOW B
 - * BLOWDN TIMEOUT A
 - * BLOWDN TIMEOUT B
 - BLOWDOWN A
 - BLOWDOWN B
 - * FEED A TIMEOUT
 - * FEED B TIMEOUT
 - FEED A
 - FEED B
 - WAITING A/B
 - SAMPLE A/B
 - HOLDING A/B
 - NORMAL

Main Menu

* **NOTE:** TRIPS DIAGNOSTIC ALARM RELAY WHEN AUX OUTPUT ASSIGNED TO ALARM FUNCTION.

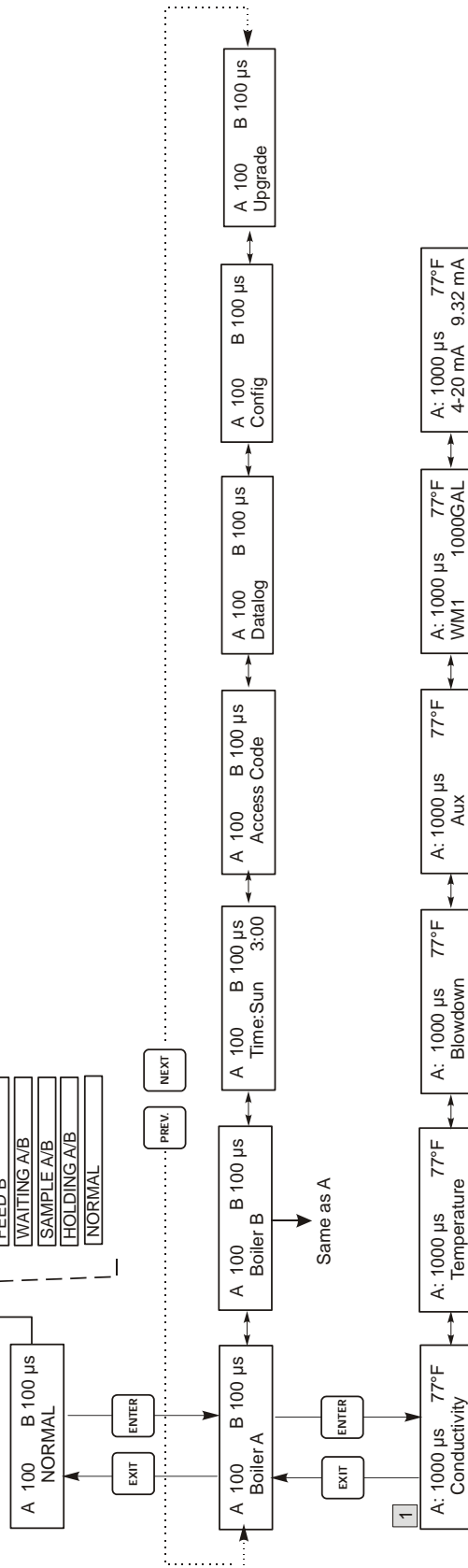

1 If using Intermittent Sampling, this menu will display "Cond" then the stage of the Sampling currently active.

Operation

- Press Enter key to enter menu.
- Press Exit key to exit menu.
- Blinking fields may be edited with the adjust arrows.

Figure 8 Main Menu

5.2 Conductivity (A or B) Menu

The conductivity menu provides the following settings: Calibration, Self Test, Unit selection, and Sampling mode setup. Additional settings are also discussed below. Refer to figure 9, Conductivity Menu Chart.

Calibrate	To Calibrate the conductivity, use either a hand held meter, or a standard solution, and adjust the controller to match. Once Calibrate is entered, the unit continuously displays conductivity readings. Press an arrow key to change the value displayed to match the hand held meter or the buffer solution. You must press ENTER to activate the new calibration. You must press the EXIT key to exit calibration. The Blowdown output is unaffected until the calibration menu is exited, so if it was ON when you entered calibration it will stay on until you exit. If you are using intermittent sampling, the Blowdown valve will open automatically when you enter the calibrate menu.
Self Test	Press ENTER to begin self test. Press any key to stop. Self Test internally simulates a conductivity sensor and should always give the reading 1000 $\mu\text{S}/\text{cm} \pm 100\mu\text{S}/\text{cm}$. If it does not, there is a problem with the electronics and the unit should be serviced. If the self-test is in the expected range, and there is a problem calibrating, then the sensor or its wiring is at fault.
Units	You may choose to display conductivity in $\mu\text{S}/\text{cm}$ or in ppm. Press ENTER and then use the Up and Down arrows to change the units. If you change the units, you will be warned to check your settings. This is important. Set points are not automatically translated from $\mu\text{S}/\text{cm}$ to ppm. If you change the units you will need to change your Blowdown settings.
ppm C.F.	This is the ppm Conversion Factor (or multiplier). This is typically 0.666 but can be changed to accommodate various requirements.
Sample Mode C / I	<p>Press enter to choose Continuous sampling or one of the types of Intermittent sampling. A 'C' at the end of the display means that sampling is continuous, an 'I' indicates Intermittent sampling, a "T" indicates Intermittent Sampling with Timed Blowdown, and a "P" indicated Intermittent Sampling with Time Proportional Blowdown.</p> <p>Continuous Continuous sampling installations allow the conductivity to be monitored continuously. If the conductivity rises above the set point, a valve is opened to drop the conductivity. No additional menus related to this blowdown mode are found in the Conductivity menu.</p> <p>Intermittent Intermittent sampling installations read the conductivity at set intervals for a given sample duration. If the conductivity is above the set point, the valve that controls the sampling will stay open until the conductivity falls below the set point. If the time the valve stays open goes beyond the sample duration, the controller will display Extend on the top status line, as well as the amount of time extended. A limit on this amount of time may be imposed; see Figure 11 Blowdown Menu.</p> <p>In intermittent sampling mode, once the set point conductivity has been reached, and the valve is closed, the conductivity will be re-checked after a programmable Hold Time with the valve still closed. If it is still below set point, the interval between samples will begin. If the conductivity with the valve closed is greater than the set point, this indicates that flashing may have caused the blowdown to stop prematurely. In this case, the sampling duration will begin again. This cycle will repeat until the conductivity is below the set point when the valve is closed.</p> <p>If any type of Intermittent sampling is chosen, the following settings will become available:</p>
Interval	This sets the amount of time between samples. This is set in Hours:Minutes and can be set between 5 minutes and 24 hours.
Duration	This is the length of each sample. This is set in Minutes:Seconds and can be set from 10 seconds to 59 minutes: 59 seconds..
Hold Time	<p>This is the amount of time that the sample will be trapped with the blowdown valve closed. The Hold Time should be set for the minimum amount of time required for the trapped sample to reach boiler pressure and rise to its maximum conductivity value. This is set in Minutes:Seconds and can be set from 1 second to 99 minutes: 59 seconds.</p> <p>If the sample mode is Intermittent with Timed Blowdown, then the sampling sequence is a little different. The controller will open the blowdown valve at the programmed Interval, for the programmed sample Duration. At the end of the sample duration time, the blowdown valve will close, and the sample will be trapped for the Hold Time.</p> <p>If the conductivity of trapped sample is greater than the set point, then blowdown valve will open for the amount of time programmed below:</p>

BlowTime (H)	<p>This is the length of time of the blowdown used in Intermittent Sampling with Timed Blowdown sampling mode. This is set in Hours:Minutes and can be set from 1 minute to 8 hours 20 minutes.</p> <p>At the end of the blowdown time, the controller will check the conductivity of a held sample once again. If the conductivity is still above the set point, another blowdown cycle will occur.</p> <p>If the sampling mode is set to Intermittent with Time Proportional Blowdown, then the blowdown valve will open at the programmed Interval, for the programmed sample Duration. At the end of the sample duration time, the blowdown valve will close, and the sample will be trapped for the Hold Time. If the conductivity of trapped sample is greater than the set point, then blowdown valve will open for a variable amount of time, depending upon how far above the set point it is. The controller uses the menus below to determine the blowdown time.</p>
Prop Band	<p>This is the conductivity value above the set point at which the maximum blowdown time will occur. This may be set for any value between 1 and 10,000 $\mu\text{S}/\text{cm}$ or ppm.</p> <p>For example, if your set point will be 2000 $\mu\text{S}/\text{cm}$, and the Prop Band is 200 $\mu\text{S}/\text{cm}$, then if the conductivity is above 2200 $\mu\text{S}/\text{cm}$ the blowdown valve will open for the Max P Time described below. If the conductivity of the trapped sample is 2100 $\mu\text{S}/\text{cm}$, the blowdown valve will open for half the Max P Time.</p>
Max P Time	<p>This is the maximum amount of blowdown time. This is set in Hours:Minutes and can be set from 1 minute to 8 hours 20 minutes. This should be set for the amount of time that it takes for the blowdown to drop the conductivity of the boiler water by the conductivity value of the Prop Band under normal loading conditions.</p> <p>At the end of the blowdown time, the controller will check the conductivity of a held sample once again. If the conductivity is still above the set point, another blowdown cycle will occur, with a new blowdown time calculated.</p>
RawCond	<p>This menu is for information only and displays the temperature-compensated conductivity reading before the user's calibration has been applied.</p>

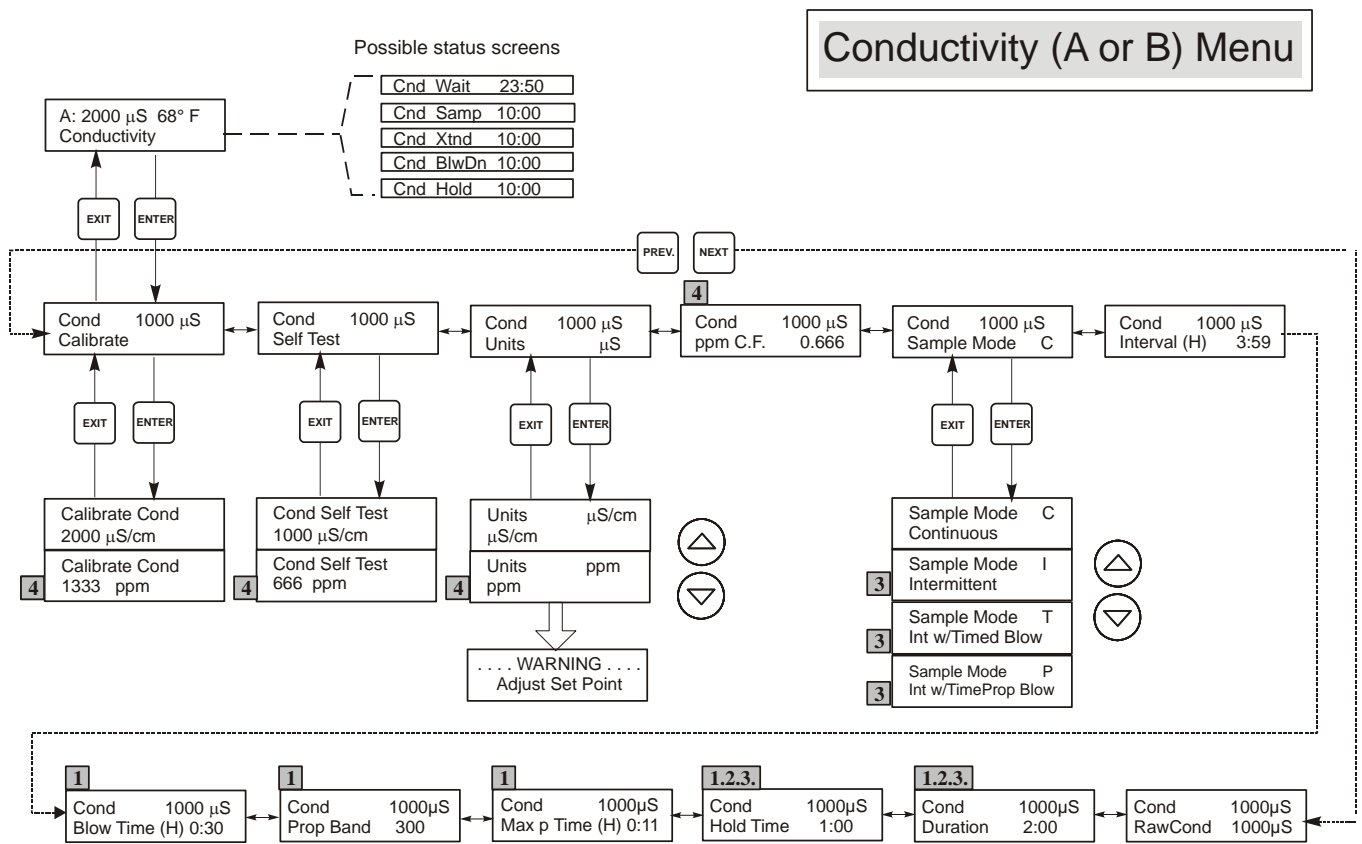

Legend

- 1** Menu choices that appear when Intermittent Sampling w/Time Proportional Blowdown is selected.
- 2** Menu choices that appear when Intermittent Sampling w/Timed Blowdown is selected.
- 3** Menu choices that appear when Intermittent Sampling is selected.
- 4** Menu choices that appear when ppm units are selected.

Operation

Press Enter key to enter menu.
 Press Exit key to exit menu.
 Blinking fields may be edited with the adjust arrows.
 Press Enter when modification is complete to return to Conductivity Menu Level.

Figure 9 Conductivity (A or B) Menu

5.3 Temperature (A or B) Menu

The Temperature menu provides the following settings: Calibration, Unit selection. The Temperature menu will be indicated on the display by one of the following:

- Temperature Normal operation
- Temp 270°F Normal operation
- Temp Error Indicates that there is a problem with the temperature input. See figure 10.

Calibrate	This menu only appears if a temperature element is connected at power-up. To Calibrate the Temperature, use a thermometer to measure the fluid temperature and adjust the WDB controller to match. Once Calibrate is entered, the unit continuously displays temperature readings. Press the Up or Down arrow key to change the value displayed to match the thermometer. You must press ENTER to activate the new calibration. You must press the EXIT key to exit calibration.
Man Temp	This menu appears only if no temperature element is connected at power-up. Use the arrow keys to adjust the temperature displayed to match that of the boiler water.
Units	You may choose to display temperature in °C or °F. Press ENTER and the Up or Down Arrow keys to change the temperature units for display.
Mode	Press ENTER and use the UP or DOWN arrow keys to select between Manual Temperature Compensation (used with sensors that do not have a temperature measuring element in them) or Automatic Temperature Compensation. If Automatic is selected, and the temperature element is not detected, the controller will display a Temp Error and revert to Manual Temp Comp until the signal is restored.

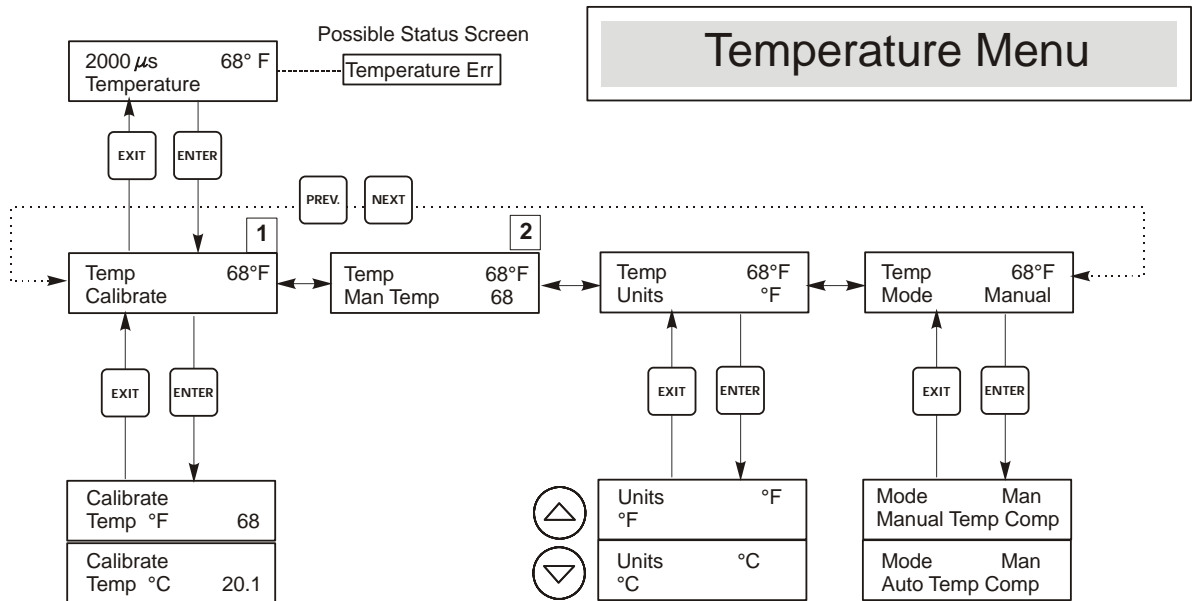

Legend

- 1** Menu wording that appears when Automatic Temperature Compensation is selected.
- 2** Menu wording that appears when Manual Temperature Compensation is selected.

Figure 10 Temperature (A or B) Menu

5.4 Blowdown (A or B) Menu

The Blowdown Menu provides the following settings: Set Point, Dead Band, Time Limit, Control Direction, HOA. The Blowdown menu will be indicated on the display by one of the following: (The 'A' indicates that the output is being controlled automatically.)

Blowdn A	OFF	Indicates that the blowdown output is currently OFF.
Blowdn A	TIMEOUT	Indicates length of time that the blowdown output has been ON.
Blowdn A	NO FLOW	Indicates that blowdown control has been suspended because there is presently no flow past the flow switch.
Blowdn A	1:01	Indicates the length of time that the Blowdown output has been ON.
Blowdn A	SAMPLE	Indicates the relay is in sampling stage of Intermittent Sampling

Set Point	This is the conductivity value at which the Blowdown valve is turned ON. The factory default setting for the WDB controller is for the Blowdown output to turn on when the conductivity is higher than the set point.	
Dead Band	This is the conductivity value that when combined with the set point determines when the blowdown output turns OFF. The blowdown output will turn off when the conductivity drops below the set point minus the Dead Band. For example: The set point is 1500 $\mu\text{S}/\text{cm}$ and the Dead Band is 200 $\mu\text{S}/\text{cm}$. The blowdown output turns ON when the conductivity reading is greater than 1500 but does not turn OFF until the conductivity drops below 1300. This setting is not used when intermittent Sampling has been selected.	
Time Limit	This menu allows you to set a maximum amount of time for the blowdown. The limit time is programmed in hours and minutes and can be set between 1 minute and 8 hours 20 minutes. If the maximum time is exceeded, the Blowdown valve will close and will not re-open until the "Reset Timer" menu is reset by an operator. If the time limit is set to zero, then the valve may be open indefinitely.	
Reset Timer	Only appears if the time limit above has been exceeded. Use the up or down arrow to change "N" to "Y", then press ENTER.	
Control Dir H / L	This allows you to set the Normal (High Set Point) or Inverse (Low Set Point) operation of the blowdown output. When set to High, the output turns on when the conductivity is higher than the set point. When set to Low, the output turns on when the conductivity is lower than the set point.	
	High Set Point	Low Set Point
H O A	The "Hand Off Auto" screen allows you to select the operating mode of the blowdown output. In Hand (manual) mode, the output is turned on immediately for a maximum of 10 minutes. If you walk away the output will return to Auto mode at the end of that time. In Off mode the output will stay Off indefinitely. In Auto mode the blowdown output will respond to changes in conductivity based on the set point. The HOA mode of the blowdown output is indicated on the blowdown status lines.	

Blowdown (A or B) Menu

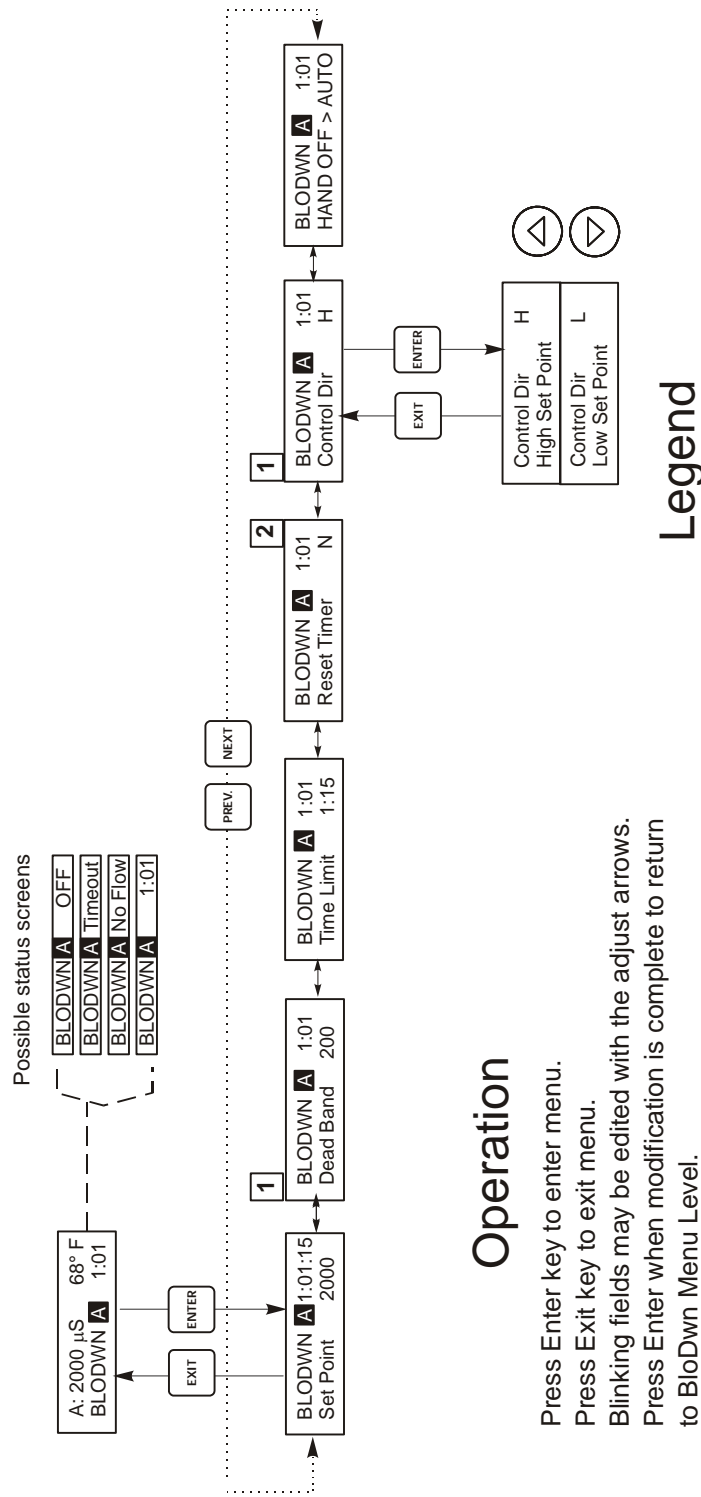

Operation

Press Enter key to enter menu.
 Press Exit key to exit menu.
 Blinking fields may be edited with the adjust arrows.
 Press Enter when modification is complete to return to BloDwn Menu Level.

Figure 11 Blowdown (A or B) Menu

5.5 Auxiliary Menu

The Auxiliary output may be used either to control a chemical feed pump or as an alarm. When setting up the controller for the first time, the Output Mode should be selected first. Press **ENTER** at the Aux menu, scroll to the Output Mode menu and press **ENTER** again. To change the output mode, press **ENTER** again and use the UP or DOWN arrow keys to toggle between "Feed" and "Alarm." Press **ENTER** when the correct choice is displayed.

5.5.1 Feed (A or B) Menu

This menu only appears if the Auxiliary output mode is set for "Feed."

NOTE: When programming the unit for the first time, it is recommended that the Chemical Feed Mode Menu be chosen first, then step through the rest of the Feed Menu indicated in figure 12.

A	Blowdown and Feed with Optional Lockout	Blowdown and Feed Mode turns the Feed output On and Off at the same time as the Blowdown output. The lockout setting determines the maximum allowable time for the Feed output. If this time is exceeded the Feed output is turned off and Locked out until the Blowdown output turns off.
B	Feed % of Blowdown	Feed % of Blowdown Mode tracks the length of time that the Blowdown output is on. When the blowdown turns off the feed output is energized for a user defined proportion of the blowdown time.
C	Feed % of Time	Feed % of Time Mode turns on the Feed output for a user definable % of a timed cycle. The time cycle length is adjustable from 10 to 60 minutes.
D	Feed based on Water Contactor Input	Feed based on Water Contactor Input Mode turns on the Feed output for a user definable time each time a water contactor pulse is detected. This contactor input can be divided to accommodate a large variety of water meters. Contacts will accumulate feed time so that all contacts are accounted for.
E	Feed based on Paddlewheel Input Mode	Turns on the Feed output for a user definable time each time a defined volume of flow is detected. This paddlewheel input has a programmable K Factor to work with a large variety of Hall Effect (square wave, not sine wave) flow meters.

The Feed menu will be indicated on the display by one of the following: (The 'A' indicates that the feed is being controlled automatically.)

Feed A	OFF	Indicates that the Feed output is currently OFF.
Feed A	10:00	Indicates the length of time that the Feed output has been ON or the length of time that the Feed output will be ON.
Feed A	TIMEOUT	Indicates that the feed relay has been on longer than the programmed maximum time.
Feed A	NO FLOW	Indicates that Feed control has been suspended because there is presently no flow past the flow switch.

Blowdown and Feed Mode	Lockout Set this for the Feed Lockout Time. The lockout time is the maximum length of time that the feed output can be on. If the lockout time is set to 0:00, the lockout timer is no longer used and the feed output will be on for as long as the blowdown is on.
Feed % of Blowdown Mode	% of Blowdown This is the % value that is multiplied times the accumulated bleed time to determine how long the feed will be. For example, if the bleed was on for 10 minutes and this setting was 50%, the feed output would be on for 5 minutes.
	Max Time This is similar to the lockout time above in that the feed output will not exceed this maximum length.
Feed % of Time Mode	% of Time This is the % value that is multiplied times the cycle length to determine the length of time that the feed output is ON. If the cycle length were 10 minutes and this setting was 40%, the feed output would be on for 4 minutes, then off for 6 minutes and then repeat the cycle.
	Cycle Time This determines the length of the cycle to be used.

Feed Based on Water Contactor Mode	Time/Cont. (Time per contact.) This determines the length of time that the feed pump should be on for each contact that is received.
	÷ Contacts By This setting allows a divider to be entered. The divider will count actual contacts from the meter until the setting is reached before a contact is considered to be received. For example, if the divider is set to 10 and the Time/Cont is set to 5:00, then the feed output would turn on for 5:00 minutes after 10 contacts were received.
	Time Limit This setting puts a limit on the amount of time that can be accumulated by the water meter input. Once this setting has been reached, all contacts will be ignored until the accumulated feed time expires. By setting Time Limit = Time/Cont., the accumulation of contacts can be disabled. <i>Hint: Program this first when initially setting up the Feed and Blowdown additions.</i>
Feed Based on Paddlewheel Mode	Time/Vol This setting determines the pump on-time once a given volume of water has passed through the paddlewheel sensor. The volume required to initiate feed is set below.
	Vol to Init. This setting determines the volume of makeup water that will initiate chemical feed.
	Time Limit This setting puts a limit on the amount of time that can be accumulated by the water meter input. Once this setting has been reached, all contacts will be ignored until the accumulated feed time expires. By setting Time Limit = Time/Vol., the accumulation of contacts can be disabled. This is set in minutes and seconds. The following settings are for all feed modes.
Chem Feed Mode A/B/C/D/E	This allows the user to select the chemical feed mode as described above.
H O A	This sets the Hand Off Auto for the feed output. This was explained in the Bleed Menu section and functions similarly. In Off position, the output will not turn ON regardless of the feed mode selected.

5.5.2 Alarm (A or B) Menu

This menu only appears if the Auxiliary output mode is set for "Alarm"

The settings here determine when the (L) and (H) indicators appear on the summary screen. The Alarm menu screen will appear as follows:

Alarm OFF
Alarm LOW ALRM
Alarm HI ALRM

Alarm % Low	This is the % below the blowdown set point that the LOW ALARM will activate. If the set point is 1000 and the % Low setting is 20 then the Low alarm will activate at 800. Entering zero will disable the Low Alarm.
Alarm % High	This is the % above the blowdown set point that the HIGH ALARM will activate. If the set point is 1000 and the % Low setting is 20 then the High alarm will activate at 1200. Entering zero will disable the High Alarm.

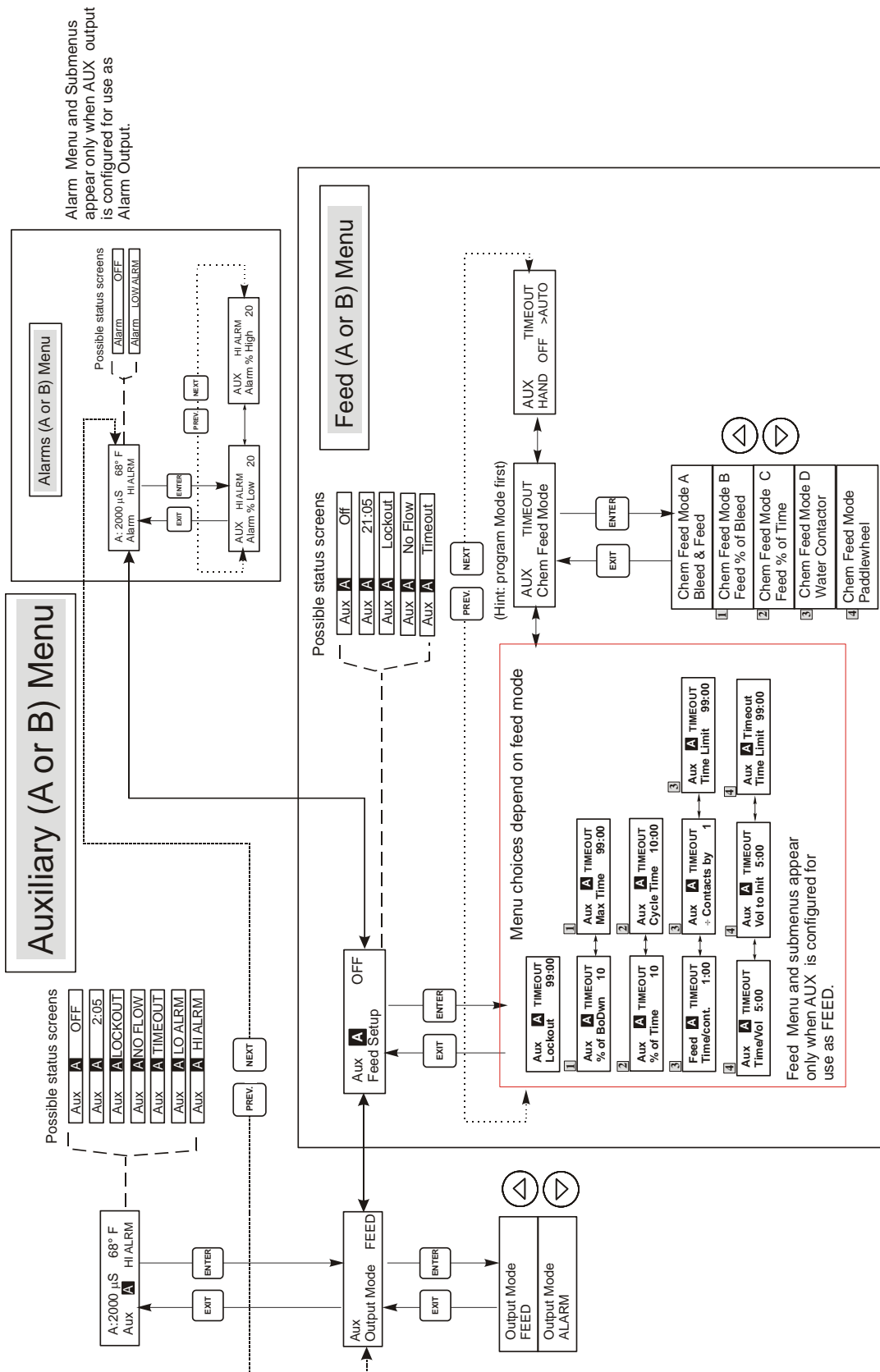

Alarm Menu and Submenus appear only when AUX output is configured for use as Alarm Output.

Operation

Press Enter key to enter menu.
 Press Exit key to exit menu.
 Blinking fields may be edited with the adjust arrows.
 Press Enter when modification is complete to return to Feed Menu Level.
 Press Enter or Adjust arrow to turn on/off output at Hand menu.

Legend

- Menu choices that appear when Feed as % of BioDwn mode is selected.
- Menu choices that appear when Feed as % of Time mode is selected.
- Menu choices that appear when Feed based on Water Contactor input is selected.
- Menu choices that appear when Feed based on Paddlewheel Input is selected.

Figure 12 Auxiliary Menu

5.6 WM1 and WM2 Menu

The Water Meter 1 and 2 menus are used to set up the type of meter and how to convert the water meter signal into volume. The Water Meter menus will be indicated on the display as follows:

WM1 100 Gal or Liters

Reset Total	This allows you to restart the totalizer display. Press the Up or Down arrow key to change the N to Y and press ENTER to reset the totalizer to 0 gal. The totalizer will count up to a maximum of 99,999,999. After that it will reset itself to zero.
Vol/cont Only appears if the Aux relay is set to Feed on Water Contactor	This allows you to set the volume of makeup per contact from the water meter.
K Factor Only appears if the Aux relay is set to Feed on Paddlewheel	Enter the number of pulses per unit volume that the paddlewheel sensor sends out. This value is usually printed on the sensor's flow cell or in its instructions.
Tot Units	This is used to set the units of measure for the totalizer. Press ENTER, then use the up and down arrow keys to toggle between "Gallons" and "Liters." Press ENTER when the desired choice is displayed.

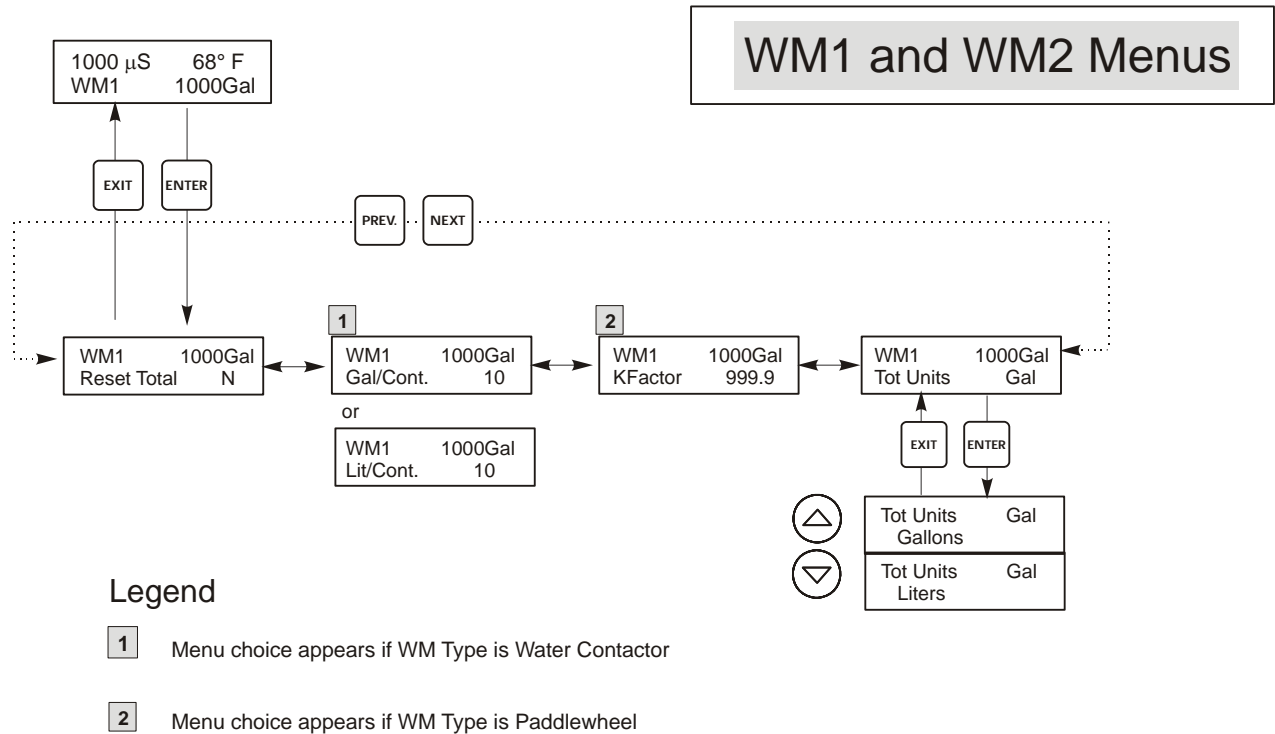

Figure 13 WM1 and WM2 Menu

5.7 Time Menu

This menu has only one choice, to set the Time used for Datalogs. This menu will appear as follows:

Time: Mon 10:20

Set Time	Press ENTER to set the Time. Use the arrow keys to adjust the day and time and then press ENTER to store or EXIT to discard.
----------	--

Time Menu

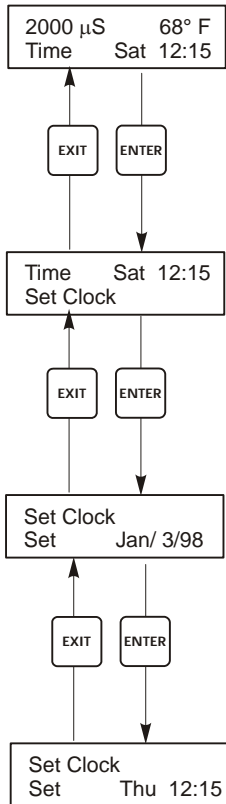

Figure 14 Time Menu

5.8 4-20mA (A or B) Menu

This menu is only available if the 4-20mA output board is installed in the controller. Installing this option board in the left hand position in the controller will assign it to Boiler A. Installing a 4-20mA option board in the right hand position assigns the output to Boiler B. See Figure 4.

This menu provides for scaling and calibrating the output. The 4-20mA menu screen appears as follows:

4-20mA 9.20mA

This indicates that the current output of the 4-20mA card is 9.20 mA.

Set 4mA Pt	This conductivity setting will correspond to a 4 mA output from the controller.
Set 20mA Pt	This conductivity setting will correspond to a 20mA output from the controller.
Calibrate	This will provide fixed 4mA and fixed 20mA outputs to allow you to calibrate connected equipment.

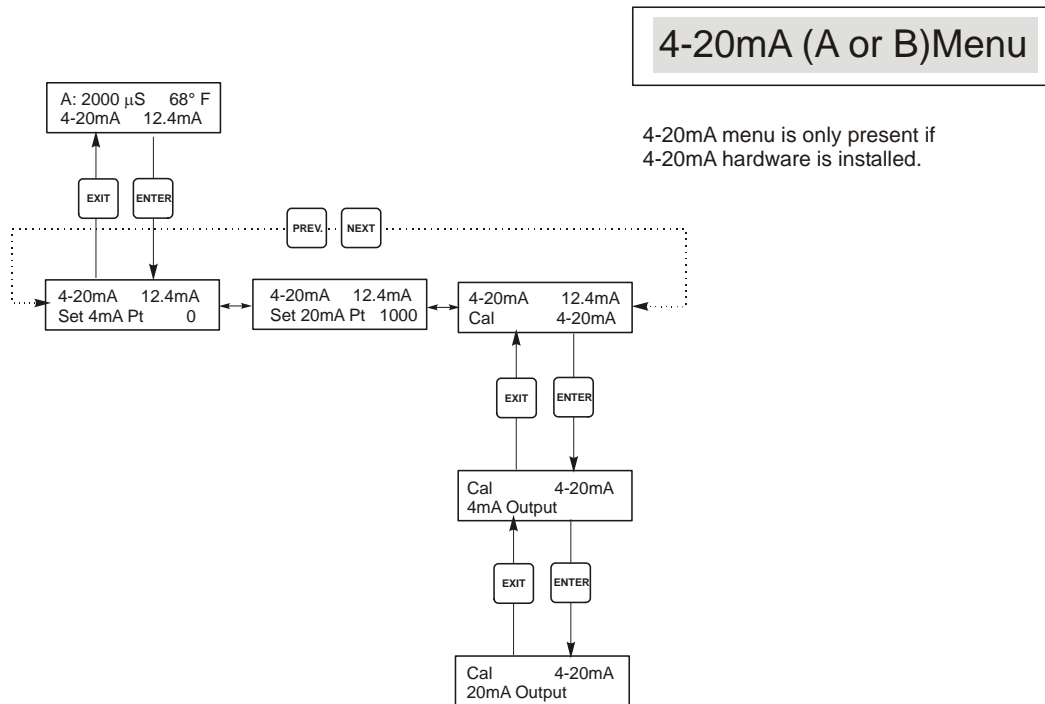

Figure 15 4-20mA (A or B) Menu

5.9 Access Code Menu

This menu determines whether the access code feature of the controller is enabled or disabled and allows you to customize the access code to your own value. The access code controls whether or not you are allowed to change the parameters in the controller. With the access code disabled, any user may change any parameter. With the access code enabled, any user can view any parameter, but cannot change them. Once an attempt is made to change a parameter, the display will prompt the user to enter the access code. If the correct access code is entered, the parameters can be changed. If the wrong access code is entered the parameters cannot be changed. Once the access code has been correctly entered, it will remain valid until there is a period of 10 minutes without a key being pressed. The access code menu will appear as shown below:

The access code menu will appear as shown below:

Access Code	DIS	Indicates that the access code is disabled. No access code is required to change any setting.
Access Code	REQ	Indicates that the access code is required to alter settings.
Access Code	OK	Indicates that the access code is required and has been entered correctly.

Enable N / Y	Press the Up or Down arrow key to change the N to Y and press ENTER to enable the access code feature. If the access code is enabled you must first enter the access code to disable it.
New Value	Press ENTER to display the current access code value and use the arrow keys to change it to any value between 0 and 9999. If the access code has been enabled, you will be prompted to enter the current access code before being allowed to change it. You must remember the access code if you enable it. The Factory default Access code is 1995. If you change the access code and can't remember it follow this procedure: 1. Turn off power to the controller. 2. Wait 10 seconds. 3. Press and Hold the UP and DOWN arrow keys while turning on the power. 4. Read the access code on the display. 5. Release the keys, and the access code will disappear.

Access Code Menu

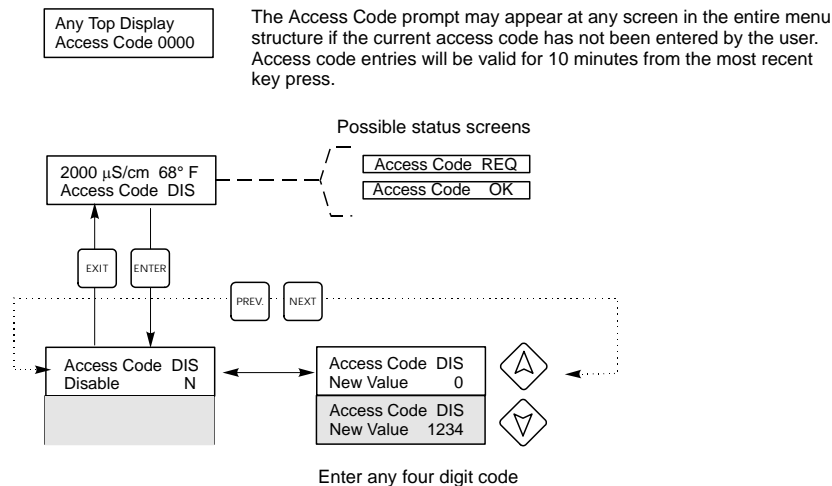

Figure 16 Access Code Menu

5.10 Datalog Menu

This is indicated in the model code by the letter U at the end of the model code. This menu allows you to save data from the controller to a USB flash drive.

The controller has four logs, the Current Datalog, the Backup Datalog, the Event Log, and the Reset Log. All files are in a CSV format that may be opened in a spreadsheet such as Microsoft Excel.

- Current Datalog** Contains the following data taken at 10 minute intervals for each boiler:
- Conductivity
 - Temperature
 - Water Meter Total
- When the current datalog is downloaded to a USB stick, it is erased and a new log file is started. If the current datalog is not downloaded before it reaches its maximum size (at least 60 days of data) the oldest data is overwritten by the newest data.
- Backup Datalog** Contains the same data as the current log but it is never erased. When the backup log reaches its maximum size (at least 60 days of data), the oldest data is overwritten by the newest data.
- Event Log** Contains columns for each relay and flow switch input, as well as the date and time. Each time any of these change state, the date and time is updated and it will show a 1 if the relay is on and 0 if it is off, and a 1 if the flow switch indicates no flow, 0 if there is flow. Tens of thousands of events will be recorded before the oldest data is overwritten by the newest, the number varying with the controller's configuration.
- Reset Log** Consists of time stamps of when power was lost, when it was returned, and the cause of the reset.

Current or Backup Datalog	<p>Place a USB flash drive with at least 10 MB capacity into the USB port on the front panel of the controller. Press the Enter key to download the file from the controller to the disk. The file name for the Current Datalog will be Datalog<serial number><date><time>.csv using the date and time it was downloaded. The file name for the Backup Datalog will be Datalog<serial number><date><time>.csv using the date and time it was created.</p> <p>The controller will display the progress of the file download process. If the file was successfully copied to the USB disk the controller will display Transfer Success.</p>	
Copy Event Log	<p>Place a USB flash drive with at least 10 MB capacity into the USB port on the front panel of the controller. Press the Enter key to download the file from the controller to the stick. The file name will be Eventlog<serial number><date><time>.csv.</p> <p>The controller will display the progress of the file download process. If the file was successfully copied to the USB disk the controller will display Transfer Success, otherwise Transfer Fail 1.</p>	
	Transfer Success	Transfer Fail 1
Copy Reset Log	<p>Place a USB flash drive with at least 10 MB capacity into the USB port on the front panel of the controller. Press the Enter key to download the file from the controller to the stick. The file name will be Resetlog<serial number><date><time>.csv.</p> <p>The controller will display the progress of the file download process. If the file was successfully copied to the USB disk the controller will display Transfer Success.</p>	
	Transfer Success	Transfer Fail 1

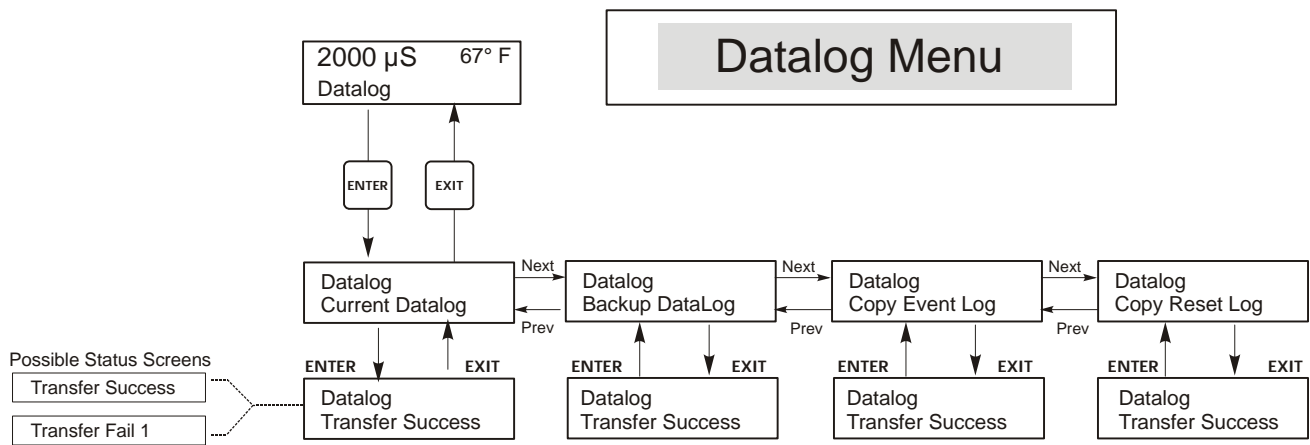

Figure 17 Datalog Menu

5.11 Config Menu

This menu allows you to export a file that contains all of the set points in the controller to a USB flash disk drive, and then later import the set points into another controller.

Export Config	Place a USB flash drive with at least 10 MB capacity into the USB port on the front panel of the controller. Press the Enter key to export the configuration file from the controller to the stick. The file name will be UCF.ini. If you are exporting files with different set points you may rename the file to something that describes it, as long as it has an ini extension. The controller will display the progress of the file download process. If the file was successfully exported to the USB disk the controller will display Transfer Success, otherwise Transfer Fail 1.	
	Transfer Success	Transfer Fail 1
Import Config	Place a USB flash drive that contains only one configuration file stored on the root directory of the stick into the USB port on the front panel of the controller. Press the Enter key to import the configuration file from the stick to the controller. The file name must have an ini extension in its name. The controller will display the progress of the file import process. If the file was successfully imported from the USB disk the controller will display one of the messages below:	
	Import Failure	Indicates that there were problems connecting to or accessing the USB stick.
	Import Success: Any key to reboot	The configuration file import succeeded and will be ready for use after reboot.
	File Open Failed	A config file could not be found on the USB stick or the USB stick file system could not be accessed.
	File Read Failed	The config file is too short (incomplete) or empty.
	Invalid CFG File	The imported file is not a valid config file.
	Invalid Model	The imported config file is not for this controller model.
	Wrong SW Version	The version of the imported config file is not compatible with this controller software version.
	Corrupt CFG File	The imported config file is corrupt. (The checksum failed.)
	Wrong file Size	The size of the imported config file is wrong.

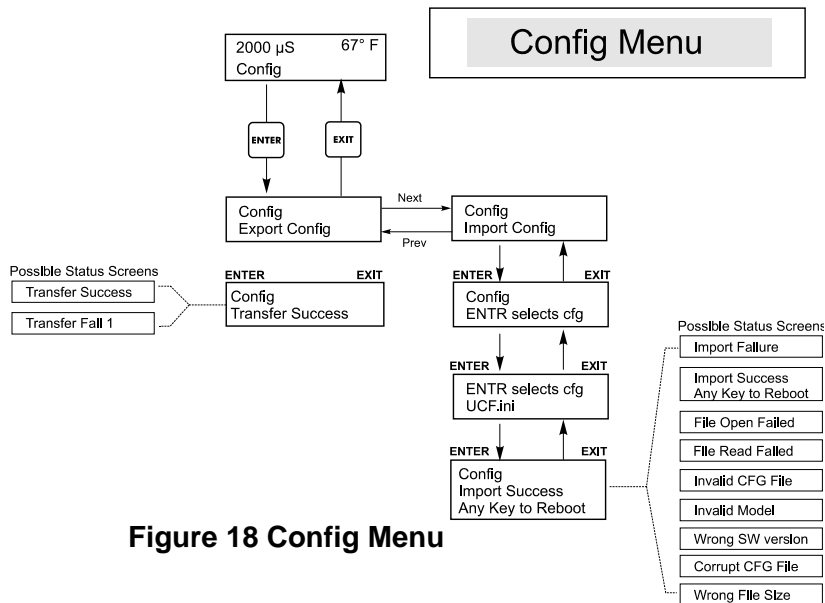

Figure 18 Config Menu

5.12 Upgrade Menu

This menu is used to upgrade the software to a newer version. If a new version of the software is available, an upgrade file will be posted on our web site. Save this file to a USB flash disk drive. It needs to be the only executable (.exe file extension) file stored on the root directory of the stick. Press the Enter key to import the software upgrade file from the stick to the controller.

The controller will display the progress of the file import process. If the file was successfully imported from the USB disk the controller will display Transfer Success. The controller will automatically reboot and come up with the new software installed.

Upgrade	The controller will display the progress of the file import process. If the file was successfully imported from the USB disk the controller will display Transfer Success. The controller will automatically reboot and come up with the new software installed. If the software upgrade fails, you will see one of the following messages:	
	UpgradFileInvald	The file found on the USB stick is for the wrong product, or is corrupt. Try getting the correct upgrade file and make sure it's the only upgrade file on the stick.
	No Upgrade File	There is no upgrade file stored on the stick, or the file is named incorrectly.
	CorrptUpgradFile	Try getting a new copy of the file.
	Flash Failure	The flash memory on the processor board has a problem. Repair or replace the front panel assembly.

To check that it was successful, turn off power to the controller, then press the Enter key while turning power on. The controller will show the software version, which should match the name of the upgrade file that you used.

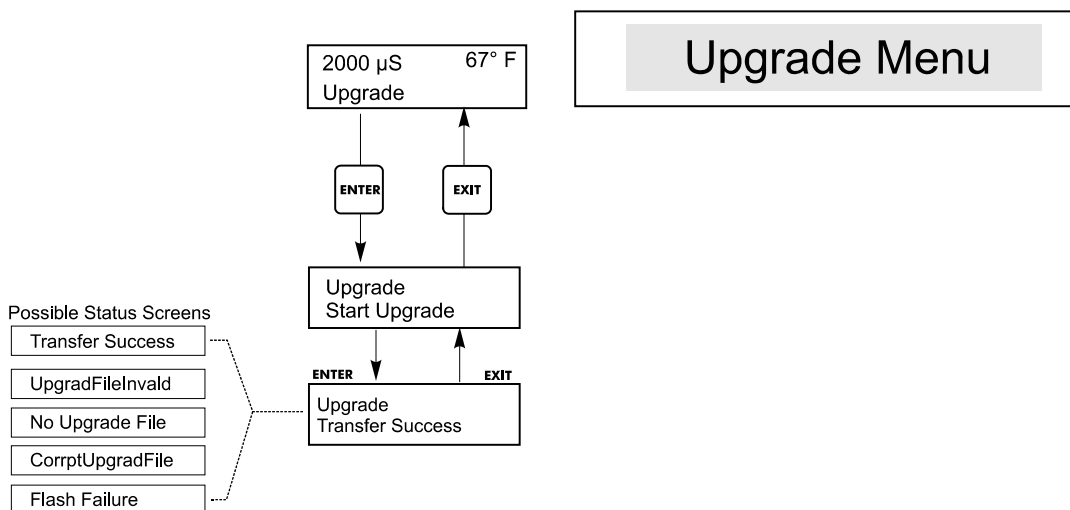

Figure 19 Upgrade Menu

6.0 MAINTENANCE

The WDB controller itself requires very little maintenance. Wipe with a damp cloth. Do not spray down the controller unless the enclosure door is closed and latched.

6.1 Electrode Cleaning

NOTE: The controller must be recalibrated after cleaning the electrodes.

Frequency

The electrodes should be cleaned periodically. The frequency required will vary by installation. In a new installation, it is recommended that the electrodes be cleaned after two weeks of service. To determine how often the electrodes must be cleaned, follow the procedure below.

1. Read and record the conductivity.
2. Remove, clean and replace the conductivity electrodes in the process.
3. Read conductivity and compare with the reading in step 1 above.

If the variance in readings is greater than 5%, increase the frequency of electrodes cleaning. If there is less than 5% change in the reading, the electrodes were not dirty and can be cleaned less often.

Cleaning Procedure

The electrodes can normally be cleaned using a cloth, toothbrush, cotton swab or paper towel and a mild cleaning solution such as 409[®] cleanser. Occasionally electrodes may become coated with various substances that require a more vigorous cleaning procedure, such as immersion in dilute muriatic acid. Usually the coating will be visible, but not always. If normal cleaning does not improve the performance, try a 1% muriatic (hydrochloric) acid rinse.

6.2 Replacing the Fuses



CAUTION: Disconnect power to the controller before opening front panel!

Locate the fuses on the circuit board at the back of the controller enclosure. (See figure 3) Gently remove the old fuse from its retaining clip and discard. Press the new fuse into the clip, secure the front panel of the controller and return power to the unit.

Warning: Use of non-approved fuses can affect product safety approvals. Fuse ratings depend on controller power rating. Specifications are shown below. To insure product safety certifications are maintained, it is recommended that a Walchem fuse is used.

F1 Fuse	Walchem P/N	F2 Fuse	Walchem P/N
5 x 20 mm, 1.0A, 250V	103163	5 x 20 mm, 6A, 250V	102834

7.0 TROUBLESHOOTING



CAUTION: Disconnect power to the controller before opening front panel!

Troubleshooting and repair of a malfunctioning controller should only be attempted by qualified personnel using caution to ensure safety and limit unnecessary further damage. Contact the factory.

7.1 Error Messages

HIGH ALARM - (main summary screen only)	
The summary screen will display an H at the right end of the bar graph if the conductivity rises above the high conductivity alarm set point. The controller will continue to check the conductivity, and the Blowdown and/or feed outputs will be allowed to be activated.	
Possible Cause	Corrective Action
Dirty electrode	Clean electrode (see Sect. 6.1)
Faulty solenoid valve	Repair or replace solenoid valve.
Faulty electrode	Evaluate (see Sect. 7.3). Check Temp display.
Improper wiring of valve or controller.	Correct wiring. (see Section 3.4)
Faulty Blowdown relay	Replace relay. (Consult factory.)
LOW ALARM	
The summary screen will display an L at the left end of the bar graph. The controller will continue to check the conductivity and feed inhibitor as programmed.	
Possible Cause	Corrective Action
Sensor disconnected	Reconnect. Check cable for continuity.
Sensor dry	Check tee for obstruction. Verify flow. Change location of electrode.
Solenoid valve stuck open	Repair or replace solenoid valve. (Consult your distributor).
Faulty electrode	Evaluate (see Section 7.3). Replace if necessary.
Improper wiring of probe	Correct wiring. (see Section 3.4)
Faulty Blowdown relay	Replace relay. (Consult factory.)
TEMP ERROR	
This error condition will stop conductivity control. It indicates that the temperature signal from the conductivity electrode is no longer valid. This prevents controlling based upon a false pH or conductivity reading.	
Possible Cause	Corrective Action
Green or white electrode wire disconnected.	Reconnect.
Faulty electrode	Evaluate (see Section 7.3). Replace if necessary. Revert to manual temperature compensation by cycling power off and on.
COND ERROR	
This error condition will stop conductivity control. It indicates that the conductivity signal from the electrode is no longer valid. This prevents controlling based upon a false conductivity reading.	
Possible Cause	Corrective Action
Black or red electrode wire shorted.	Disconnect short.
Faulty electrode	Evaluate (see Section 7.3). Replace if necessary.
Faulty controller	Verify via failed self-test.

BLOWDOWN TIMEOUT	
This error condition will stop conductivity control. It is caused by the blowdown output being activated for longer than the programmed Blowdown Time Limit.	
Possible Cause	Corrective Action
Programmed value too low for normal conditions.	Increase Blowdown Time Limit.
Blowdown flow rate too low.	Check for clogged strainer. Check for insufficient pressure differential.
Blowdown valve not opening.	Check blowdown valve wiring. Check controller relay.
FEED TIMEOUT	
This error condition will stop the feed pump for that particular feed cycle. If feed is initiated again, the feed pump will be allowed to activate. The error condition is caused by the feed output being activated for longer than the programmed limit.	
Possible Cause	Corrective Action
Programmed value too low for normal conditions.	Increase Feed Time Limit. (May also be called Max Time or Lockout)
Blowdown took too long. (Blowdown & Feed or Feed as % of Blowdown only)	See Blowdown Timeout Troubleshooting.
Pumping problem.	Check chemical supply. Check pump for prime. Check tubing for blockage or leaks.
Controller problem.	Check output wiring. Check controller relay.
COND HIGH ALARM	
This error message indicates that the conductivity is above the programmed percentage above set point. The conductivity will continue to be monitored, and the blowdown and feed outputs will be allowed to be activated.	
Possible Cause	Corrective Action
Fouled conductivity electrode.	See Conductivity Electrode Troubleshooting section.
Blowdown flow rate too low.	Check for clogged strainer. Check for insufficient pressure differential.
Blowdown valve not opening.	Check for faulty blowdown valve. Check blowdown valve wiring. Check controller relay.
Conductivity rose over alarm limit while biocide lockout occurred.	Allow normal blowdown to occur.
COND LOW ALARM	
This error message indicates that the conductivity is below the programmed percentage below set point. The conductivity will continue to be monitored, and the blowdown and feed outputs are allowed to be activated.	
Possible Cause	Corrective Action
Fouled conductivity electrode.	See Conductivity Electrode Troubleshooting section. (sections 6.1 and 7.3)
Electrode disconnected.	Reconnect.
Electrode dry.	See "No Flow" Troubleshooting section.
Blowdown valve stuck open.	Check for faulty blowdown valve. Check blowdown valve wiring. Check controller relay.
Flashing.	Remove flow restriction upstream from electrode. Increase flow restriction downstream from electrode. Install sample cooler. Move skimmer line below water level or raise water level.

7.2 Conductivity Readout Does Not Change

If the readout is stuck at or near zero:	
Possible Cause	Corrective Action
1. Dry electrode	Check for flow through system.
2. Electrode is disconnected.	Check wiring to electrode. Go to self-test menu, as described in section 5.2. If readout changes to 900-1100, the problem is with electrode or connections. (see section 7.3) If still at zero, problem is with controller. Consult the factory.
If the readout is stuck at another number:	
Possible Causes	Corrective Action
1. Dirty or faulty electrode	Evaluate electrode (see Section 7.3).
2. Stagnant sample	Check system for proper flow.

7.3 Procedure for Evaluation of Conductivity Electrode

Can be used for troubleshooting a sensor error message, low conductivity, high conductivity, conductivity stuck at 0, cal failure, and/or conductivity stuck at a number other than 0.

Try cleaning the electrode first (refer to Sect. 6.1).

To find out if the electrode or the controller is faulty, step through the Self-Test menu, as described in section 5.2. The display should read $1000 \pm 100 \mu\text{S}/\text{cm}$. This indicates that the controller is OK and the problem is in the probe or its connections. If it does not read $1000 \pm 100 \mu\text{S}/\text{cm}$, return the control module for repair.

To check the electrode, check the electrode connections to the terminal strip (refer to Figure 3). Make sure that the correct colors go to the correct terminals, and that the connections are tight. Restore power and see if the conductivity is back to normal. If not, replace the electrode.

7.4 Procedure for Checking Relay Outputs

If any pre-wired output is not activating the device (pump, valve, etc.) attached to it:

Verify that the pump or valve is not faulty by plugging it directly into a wall socket.

In some controllers, certain relays are NOT internally powered. Check the instruction manual to determine if the relay is a dry contact type. If so, make sure that external power (115 VAC) has been connected to the relay. In most cases, this will be a jumper wire from the large screw labeled "HOT" to one of the relay terminals.

Manually activate the relay using the hand-off-auto menu. Verify that the LED on the front panel lights up. If the device turns on, there must be a problem with the set points if the device doesn't turn on when it should.

With power removed, check the wiring of the pigtail to the terminal strips. Make sure that they are not loose, that they are not connected by the wire's jacket, and that they are connected to the correct terminal. Also check the removable terminal block where the black (hot) wires attach (TB2) to see if it has pulled loose. Restore power and manually activate the relay.

With power removed, remove the terminal block that has the black (hot) wires from all of the pigtailed (TB2). This simply pulls up off some metal pins. Check these pins for corrosion. If they seem coated with anything, scrape off the coating by replacing and removing the terminal block several times. Restore power and manually activate the relay.

With power removed, remove the TB2 terminal block again, and attach one lead of a multimeter to the pin that lines up with the wire for the relay in question, and the other lead on the other side of the relay (this will be an adjacent pin for a dry contact relay, or neutral at TB3 for a powered relay). Set the meter to read resistance. Restore power and verify that the meter reads infinite ohms with the relay off (open) and very low ohms with the relay on (closed). If it always reads infinite ohms, the controller is faulty.

7.5 No Display

Verify that the controller has power. Check F1 fuse.

If a 4-20 mA output option board has been installed, make sure that it is not installed crooked (off by one pin on the connector).

Make sure that the ribbon cable has not been removed and re-installed backwards. See Figure 4.

8.0 SERVICE POLICY

The WDB series Boiler Conductivity Controller has a 2-year warranty on electronic components and a 1-year warranty on mechanical parts (keypad, terminal strip and relays).

We stock circuit boards for immediate exchange after we have isolated the cause of the problem.

Factory authorized repairs that are received by next-day-air will be returned within 24 hours. Normal priority for returns is two weeks.

Out of warranty repairs or circuit board exchanges are done on a flat fee basis after the warranty is expired.

Model Code

WDB400

-

Voltage

Output

Sensor

U (USB)

VOLTAGE

1 = 120 VAC, prewired

5 = 100-240 VAC, conduit

OUTPUT

N= No data output

4 = Isolated 4-20 mA output

2 = Two isolated 4-20 mA outputs

SENSOR

N = No electrode

5 = Standard electrode (up to 250 psi)

USB FEATURES

U = Integrated datalogging, event/reset logging, and configuration file import/export de archivos

FIVE BOYNTON ROAD
TEL: 508-429-1110

HOPPING BROOK PARK
FAX: 508-429-7433

HOLLISTON, MA 01746 USA
Web: www.walchem.com