

WALCHEM

IWAKI America Inc.

WEC/WDEC410 Controllers

WEC/WDEC410 Series Electrodeless Conductivity Controller Instruction Manual

Five Boynton Road Hopping Brook Park Holliston, MA 01746 USA

TEL: 508-429-1110 FAX: 508-429-7433 WEB: www.walchem.com

Notice

© 2014 WALCHEM, Iwaki America Inc. (hereinafter "Walchem")
5 Boynton Road, Holliston, MA 01746 USA
(508) 429-1110
All Rights Reserved
Printed in USA

Proprietary Material

The information and descriptions contained herein are the property of WALCHEM. Such information and descriptions may not be copied or reproduced by any means, or disseminated or distributed without the express prior written permission of WALCHEM, 5 Boynton Road, Holliston, MA 01746.

This document is for information purposes only and is subject to change without notice.

Statement of Limited Warranty

WALCHEM warrants equipment of its manufacture, and bearing its identification to be free from defects in workmanship and material for a period of 24 months for electronics and 12 months for mechanical parts and electrodes from date of delivery from the factory or authorized distributor under normal use and service and otherwise when such equipment is used in accordance with instructions furnished by WALCHEM and for the purposes disclosed in writing at the time of purchase, if any. WALCHEM's liability under this warranty shall be limited to replacement or repair, F.O.B. Holliston, MA U.S.A. of any defective equipment or part which, having been returned to WALCHEM, transportation charges prepaid, has been inspected and determined by WALCHEM to be defective. Replaceable elastomeric parts and glass components are expendable and are not covered by any warranty.

THIS WARRANTY IS IN LIEU OF ANY OTHER WARRANTY, EITHER EXPRESS OR IMPLIED, AS TO DESCRIPTION, QUALITY, MERCHANTABILITY, FITNESS FOR ANY PARTICULAR PURPOSE OR USE, OR ANY OTHER MATTER.

180364.L
June 2014

TABLE OF CONTENTS

1.0	INTRODUCTION.....	1
2.0	SPECIFICATIONS	2
2.1	Measurement Performance	2
2.2	Electrical: Input/Output	2
2.3	Mechanical.....	2
2.4	WEC Variables and their Limits	3
3.0	UNPACKING & INSTALLATION.....	4
3.1	Unpacking the unit.....	4
3.2	Mounting the electronic enclosure.....	4
3.3	Installation.....	4
3.4	Icon Definitions	5
3.5	Electrical installation	7
4.0	FUNCTION OVERVIEW	12
4.1	Front Panel	12
4.2	Display	12
4.3	Keypad.....	13
4.4	Access Code.....	13
4.5	Startup	14
4.6	Shut Down	14
5.0	OPERATION.....	15
5.1	Main Menu	15
5.2	Sensor Menu.....	17
5.3	Temperature Menu	21
5.4	Control 1 - 4 Menus	22
5.5	Interlock A Menu	26
5.6	4-20 mA 1 and 2 Menus (Optional).....	27
5.7	Time Menu	28
5.8	Access Code Menu.....	29
5.9	Datalog Menu.....	30
5.10	Config Menu.....	32
5.11	Upgrade Menu	34
6.0	MAINTENANCE	35
6.1	Sensor Cleaning	35
6.2	Replacing the Fuses	35
7.0	TROUBLESHOOTING	36
7.1	Error Messages.....	36
7.2	Interferences	38
8.0	SERVICE POLICY	39

1.0 INTRODUCTION

The Walchem WEC410 Series controllers are wall mount electrodeless conductivity controllers. The non-contacting sensor may be used for long periods of time in dirty, oily solutions without fouling. Common applications include cleaners, chromates, phosphating baths, acid pickling baths and rinse tanks. Two sensors may be attached to control two separate baths in WDEC models.

Four control relays are available that may be set up to feed chemicals, or as alarms. A fifth relay is used as a diagnostic alarm. One or two isolated 4-20 mA outputs that are proportional to the conductivity or temperature are optional.

Any set point may be viewed without interrupting control. Each set point change will take effect as soon as it is entered. An access code is available to protect set point parameters, while still allowing settings to be viewed.

Sensors are available in CPVC or in PEEK materials to be compatible with the chemicals in your process. Sensors are available in four different conductivity ranges, and for either in line or submersion mounting.

Our unique USB feature provides the ability to upgrade the software in the controller to the latest version.

An advanced USB capability option is available. The Configuration file feature allows you to save all the set points from a controller onto a USB flash disk, and then import them into another controller, making the programming of multiple controllers fast and easy. The data logging feature allows you to save the last 2 month's readings and events to a USB flash disk.

2.0 SPECIFICATIONS

2.1 Measurement Performance

Conductivity Range	1000 μ S/cm	10,000 μ S/cm	100mS/cm	1000mS/cm
Conductivity Resolution	1 μ S/cm	1 μ S/cm	1mS/cm	1mS/cm
Conductivity Accuracy	\pm 3% (below 50 μ S/cm accuracy \pm 25%)	\pm 1% (below 1000 μ S/cm accuracy \pm 25%)	\pm 1% (below 10 mS/cm accuracy \pm 25%)	\pm 1% (below 100 mS/cm accuracy \pm 25%)
Temperature Compensation			100 Kohm	
Temperature Range			32-212°F (0-100°C)	
Temperature Resolution			\pm 1°F (1°C)	
Temperature Accuracy			\pm 1°F (\pm 1°C)	

2.2 Electrical: Input/Output

Input Power	100-240 VAC, 50/60 Hz, 8A Fuse: 1.0 ampere, 5 x 20 mm
Input Signals	
Conductivity	\pm 2000 mV
Temperature Compensation	100 Kohm
Interlock (optional)	Isolated, dry contact closure required (i.e., flow, level, etc.)
Outputs	
Mechanical Relays (5)	Internally powered relays switching line voltage 6 A (resistive), 1/8 HP All relays are fused together as one group, total current for this group must not exceed 6A

Note: The Alarm relay is non-programmable. Refer to the Main Menu diagram for the list of error conditions that trigger the alarm relay.

4 - 20 mA 1 or 2 (optional)	Internally powered Fully isolated 600 Ohm max resistive load Resolution .001% of span Accuracy \pm 1% of reading
Sensor Power	\pm 5 VDC, 5 mA

Agency Approvals

Safety	UL 61010-1:2012 3rd Ed. CSA C22.2 No. 61010-1:2012 3rd Ed. IEC 61010-1:2010 3rd Ed. EN 61010-1:2010 3rd Ed.
EMC	IEC 61326-1:2005 EN 61326-1:2006

Note: For EN61000-4-6, EN61000-4-3 the controller met performance criteria B.

*Class A equipment: Equipment suitable for use in establishments other than domestic, and those directly connected to a low voltage (100-240 VAC) power supply network which supplies buildings used for domestic purposes.

2.3 Mechanical

Controller Specifications

Enclosure Material	Polycarbonate
NEMA Rating	NEMA 4X
Dimensions	8.5" x 6.5" x 5.5"
Display	2 x 16 character backlit liquid crystal
Operating Ambient Temp	32 – 122°F (0 – 50°C)
Storage Temperature	-20 – 180°F (-29 – 80°C)

Sensor Specifications

Sensor Material:	CPVC	PEEK
O-Ring Material:	FKM (in-line only)	N/A
Mounting Adapter Material:	CPVC (in-line only)	316 SS (in-line only)
Dimensions:	7" long x 1.75" diameter	7" long x 1.75" diameter
Sensing Coil:	0.5 (1.3cm) aperture	0.5 (1.3cm) aperture
Temperature Limitations:	0 to 158°F (0 to 70°C)	0 to 190°F (0 to 88°C)
Pressure Rating:	0 to +150 psi (0 to 1 MPa)	0 to +150 psi (0 to 1 MPa)
Mounting:		
Submersion	1" NPTM thread	1" NPTM thread
In-Line	2" NPTM adapter	2" NPTM adapter

2.4 WEC/WDEC Variables and their Limits

		Low Limit	High Limit
Sensor menu			
	Days Between Calibration	0 days (no reminder)	59 days
	PPM Conversion Factor	0.2	1.0
	Multipoint Calibration	2 points	5 points
	% Concentration	0%	200.0%
	Damping	12 seconds	48 seconds
Temperature Menu	Temperature Compensation	0.00% per °C	9.99% per °C
Control 1 -4 Menus			
	High or Low Set Point	0 (units set by user)	Full scale of sensor range or 300% concentration
	High or Low Alarm Point	0 (units set by user)	Full scale of sensor range or 300% concentration
	Dead Band	0 (units set by user)	Full scale of sensor range or 300% concentration
	Proportional Band	0 (units set by user)	Full scale of sensor range or 300% concentration
	Sample Period (set in min:sec)	0:01	30:00
	Time Limit (set in min:sec)	0:01	59:59 (enabled) 0=unlimited (disabled)
4-20 mA 1 and 2 Menus	4 & 20 mA Settings	0 (units set by user)	Full scale of sensor range or 300% concentration
Access Code Menu	New Value	0	9999
Datalog Menu (Optional)		No variables	
Config Menu (Optional)		No variables	
Upgrade Menu		No variables	

*Note: The Alarm relay is non-programmable. Refer to the Main Menu diagram for the list of error conditions that trigger the alarm relay.

3.0 UNPACKING & INSTALLATION

3.1 Unpacking the unit

Inspect the contents of the carton. Please notify the carrier immediately if there are any signs of damage to the controller or its parts. Contact your distributor if any of the parts are missing. The carton should contain: a WEC series controller and instruction manual. Any options or accessories will be incorporated as ordered.

3.2 Mounting the electronic enclosure

The WEC series controller is supplied with mounting holes on the enclosure. It should be wall mounted with the display at eye level, on a vibration-free surface, utilizing all four mounting holes for maximum stability. Use M6 (1/4" diameter) fasteners that are appropriate for the substrate material of the wall. The enclosure is NEMA 4X rated. The maximum operating ambient temperature is 122°F (50°C); this should be considered if installation is in a high temperature location. The enclosure requires the following clearances:

Top:	2" (50 mm)
Left:	8" (203 mm)
Right:	4" (102 mm)
Bottom:	7" (178 mm)

3.3 Installation

Once the WEC series controller is mounted, the metering pumps may be located at any distance from the controller.

- Mount the sensor as close as possible to the controller.
- Use only Walchem extension cable if 20 feet (6 meters) of cable is not sufficient.
- Take care to shield the cable properly.
- Maximum cable length is 250 feet (76 meters).
- Position the sensor such that a fresh, representative sample of the solution is available.
- Position the sensor such that air bubbles will not be trapped within the sensing area.
- Position the sensor where sediment or oil will not accumulate within the sensing area.
- If cable is installed in metal conduit (recommended), either flexible conduit should be used or some other provision made for removal of sensor from the process for maintenance.





Refer to the WEC Sensor Instructions for more detailed information.

For submersion applications, mount the sensor below the minimum solution level. The sensor cable is not waterproof and must be protected from moisture by connecting a pipe to the top of the sensor. The opposite end of the pipe should also be protected from moisture using a cable gland. Do not install the sensor in the path of any electrical current that may be flowing in the solution, as this will shift the conductivity reading.

For in-line applications, where the sensor is installed in a pipe, it should be placed on the discharge side of the pump (under positive pressure). The sensor should be installed in an area where there is good solution movement and where it will respond rapidly to chemical additions. The placement of the sensor relative to the placement of chemical replenishment, along with the quality of the mixing and replenishment flow rate, is critical to accurate control.

IMPORTANT: To avoid cracking the female pipe threads on the supplied plumbing parts, use no more than 3 wraps of Teflon tape and thread in the pipe FINGER tight plus 1/2 turn! ***Do not use pipe dope to seal the threads of the flow switch because the clear plastic will crack!***

3.4 Icon Definitions

Symbol	Publication	Description
	IEC 417, No.5019	Protective Conductor Terminal
	IEC 417, No. 5007	On (Supply)
	IEC 417, No. 5008	Off (Supply)
	ISO 3864, No. B.3.6	Caution, risk of electric shock
	ISO 3864, No. B.3.1	Caution

Installation with Submersion sensor

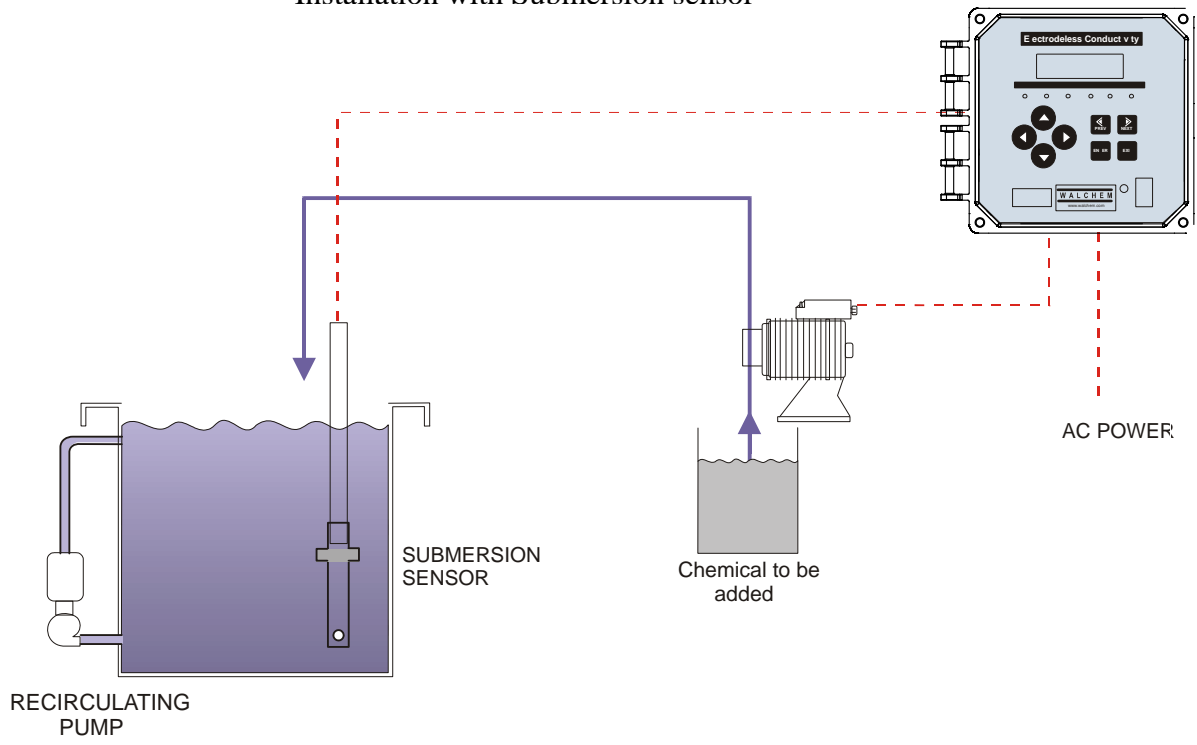

Figure 1 Typical Installation

3.5 Electrical installation

The various standard wiring options are shown in figure 2. Your WEC series controller will arrive from the factory prewired or ready for hardwiring. Depending on your configuration of controller options, you may be required to hardwire some or all of the input/output devices. Refer to figures 3 and 4 for circuit board layout and wiring.

Note: when wiring the optional 4-20 mA output or a remote interlock switch, it is advisable to use stranded, twisted, shield pair wire between 22-26 AWG. Shield should be terminated at the controller ground stud (see figures 3 and 4).



CAUTION



1. There are live circuits inside the controller even when the power switch on the front panel is in the OFF position! The front panel must never be opened before power to the controller is REMOVED!
If your controller is prewired, it is supplied with a 8 foot, 18 AWG power cord with USA style plug. A tool (#1 Phillips driver) is required to open the front panel.
2. When mounting the controller, make sure there is clear access to the disconnecting device!
3. The electrical installation of the controller must be done by trained personnel only and conform to all applicable National, State and Local codes!
4. Proper grounding of this product is required. Any attempt to bypass the grounding will compromise the safety of persons and property.
5. Operating this product in a manner not specified by Walchem may impair the protection provided by the equipment.

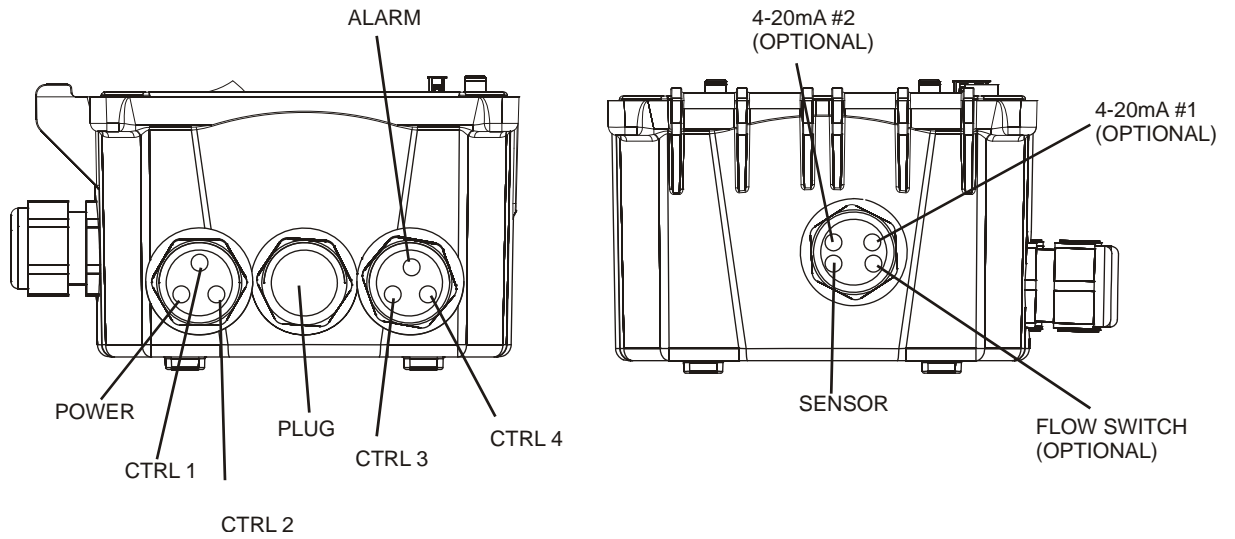

Figure 2a WEC410 Conduit Wiring

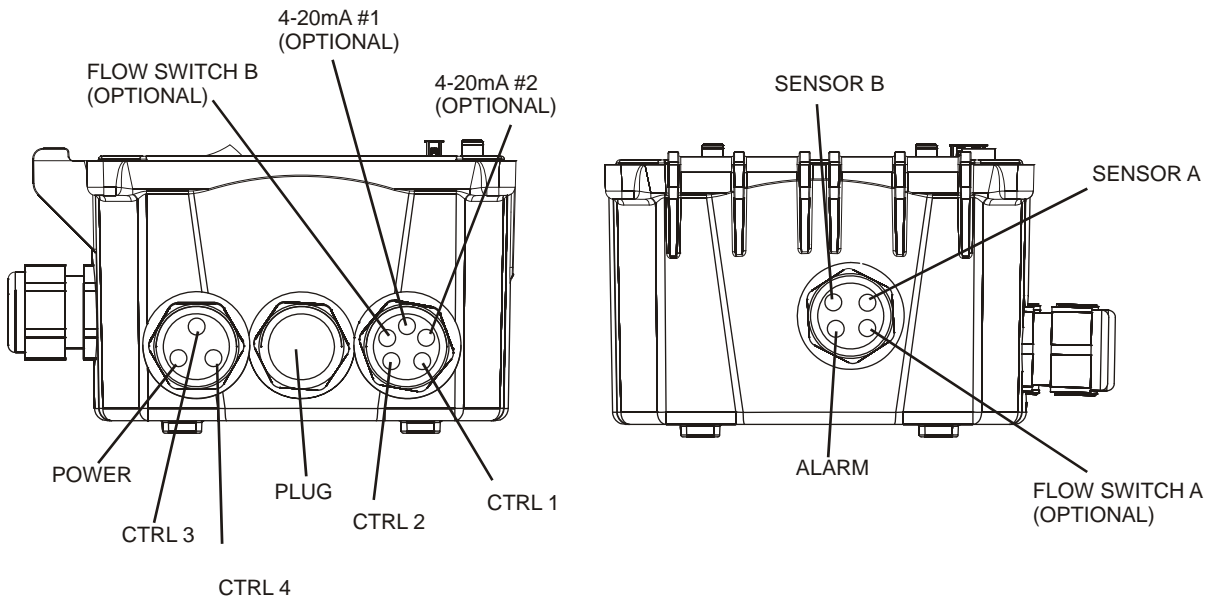

Figure 2b WDEC420 Conduit Wiring

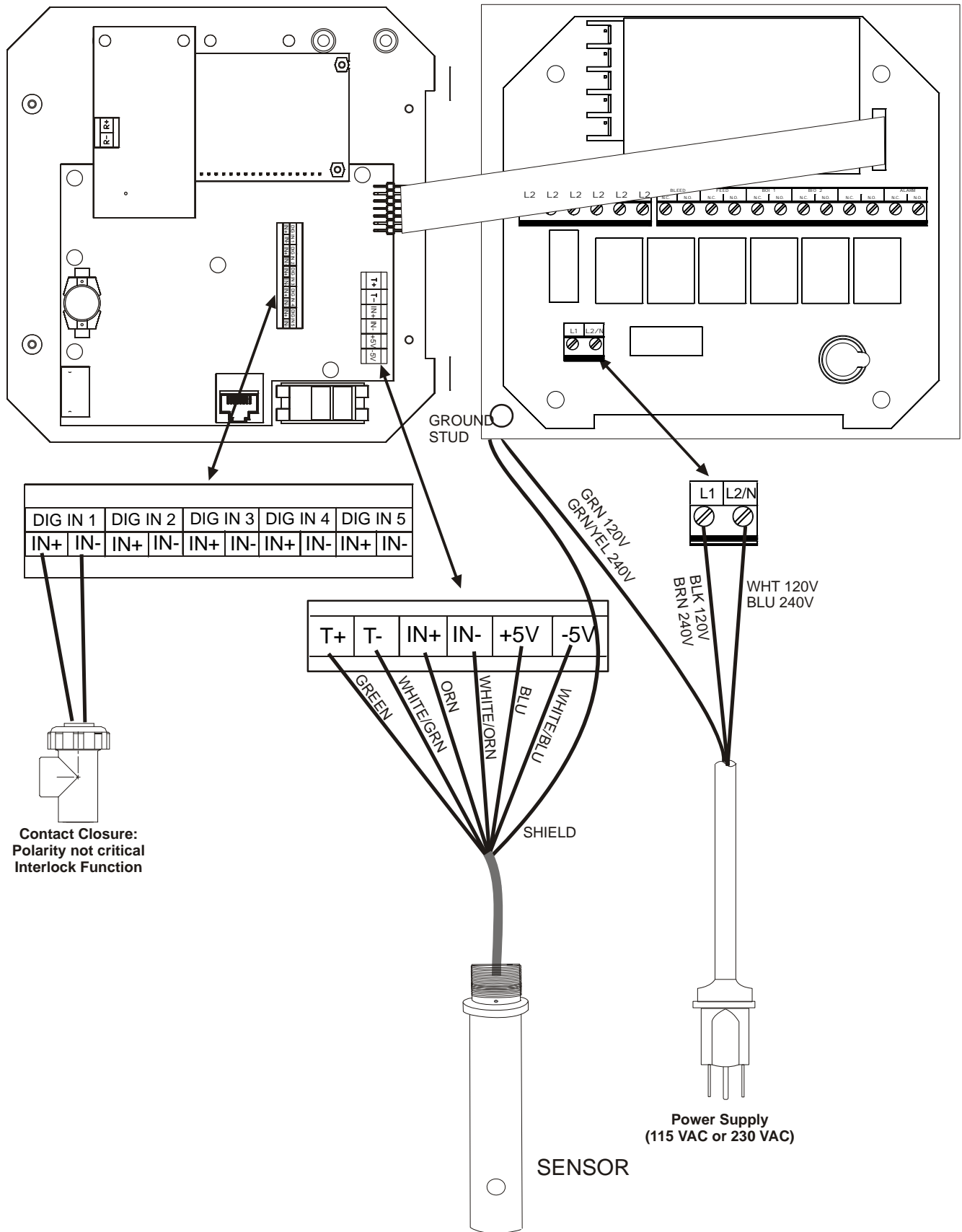

Figure 3a WEC410 Input Wiring

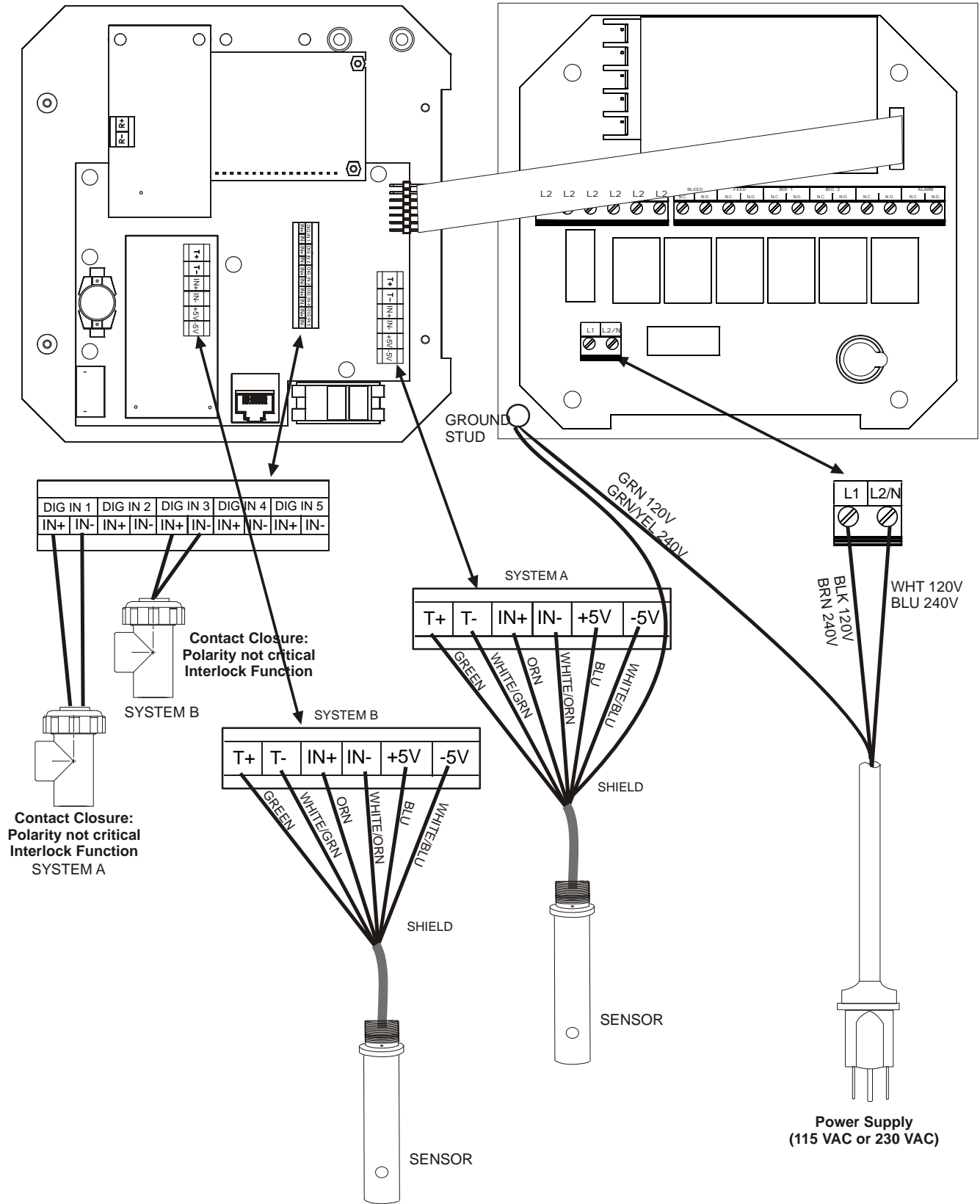

Figure 3b WDEC410 Input Wiring

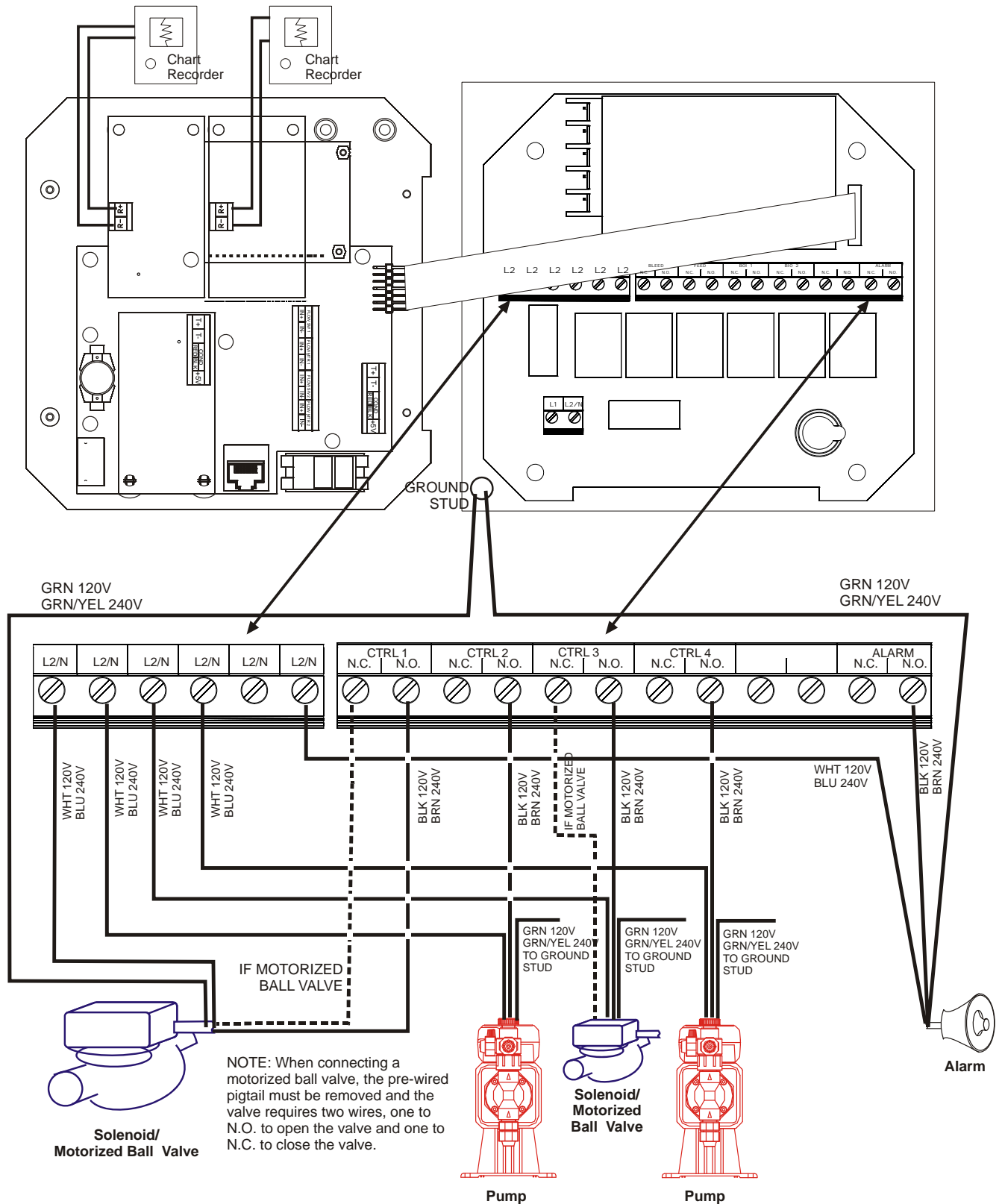

Figure 4 WEC410 or WDEC410 Outputs

4.0 FUNCTION OVERVIEW

4.1 Front Panel

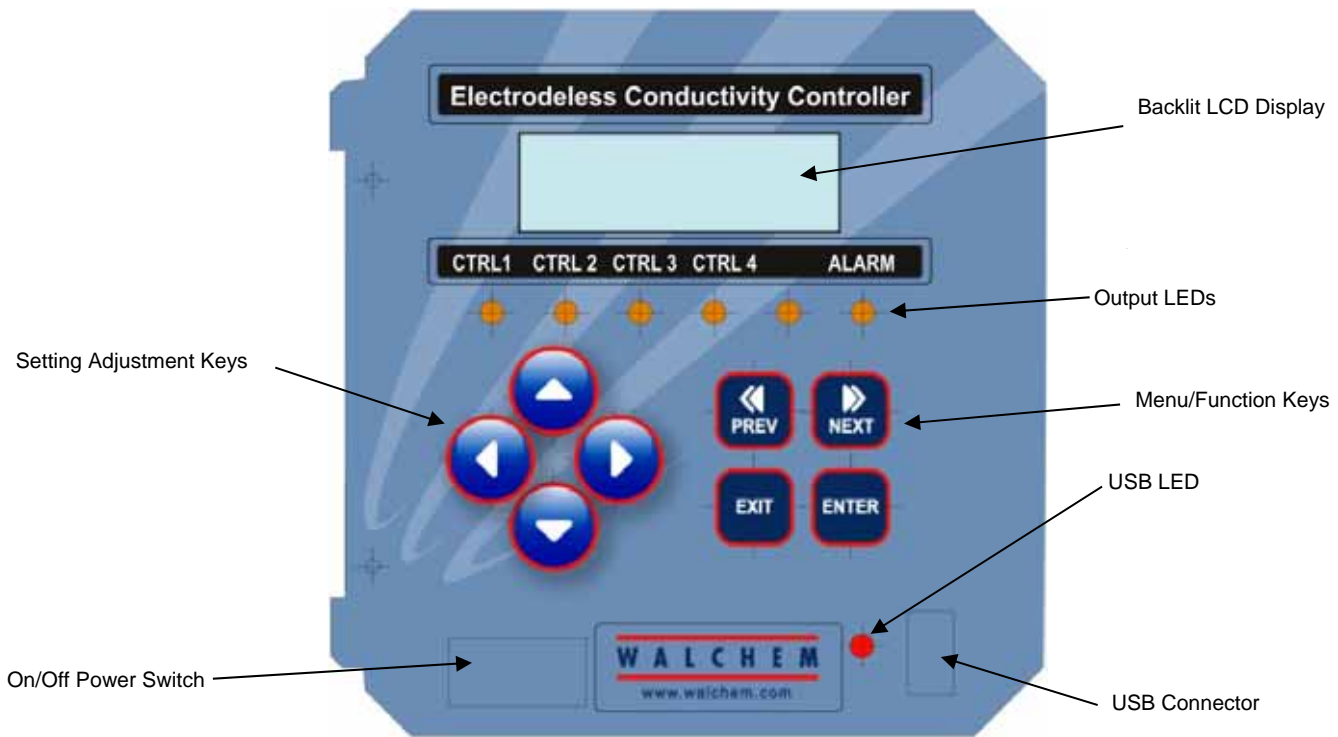

Figure 5 Front Panel

4.2 Display

A summary screen is displayed while the WEC controller is on. If you have a single sensor (WEC), this display will show a bar graph of the conductivity relative to the set point, the actual conductivity value or ppm or percent concentration, and current operating conditions. If you have two sensors (WDEC), the bar graph will be replaced by the other sensor's conductivity value.

The center of the bar graph is at the (S), which represents the set point. For each 1% increase in conductivity, a vertical bar appears and the bar graph will grow to the right. There are small breaks in the bars at each 5%. The bar graph is limited to displaying 20% above and below the set point. On the 1000 μ S scale, for example, if the set point is 850 μ S, a value of 680 μ S will be a single vertical bar at the left side. A value of 1020 μ S will be a full bar graph extending all the way to the right side.

The bottom line of the summary screen displays the following potential status messages: Probe Error, Temp Sensor Err, Calibration Time, Output Timeout, High/Low Alarm, Range Alarm, In Range Output, Output On, Normal and Interlock.

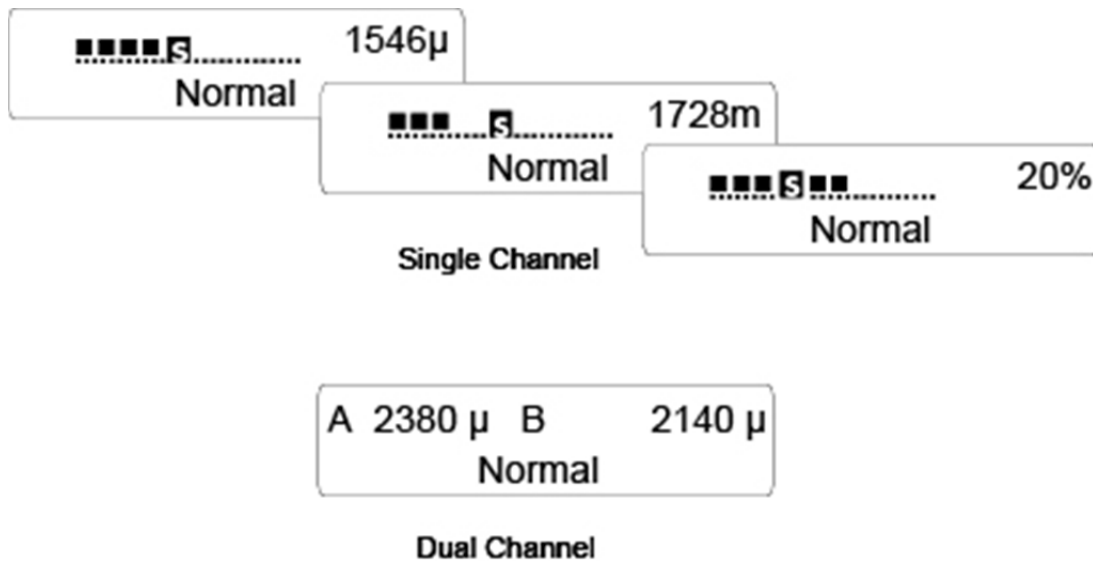

Figure 6 Summary Screen

4.3 Keypad

The keypad consists of 4 directional arrow keys and 4 function keys. The arrows are used to move the adjustment cursor and change settings, while the function keys are used to enter values, and navigate the various menu screens. The function keys are **ENTER**, **EXIT**, **NEXT**, and **PREV** (previous). **NEXT** and **PREV** scroll through the various menu choices. **ENTER** is used to enter a submenu and to enter a value. **EXIT** is used to back up one menu level. If you are at the main menu level, **EXIT** will return you to the Summary Display.



To change a value in a submenu, the left/right arrow keys move the cursor left and right to each digit or option that can be changed. The up/down arrows will change numeric values up or down, or scroll through option choices. Press **ENTER** only when you have finished making all of the changes for that menu screen.

4.4 Access Code

The WEC series controller is shipped with the access code disabled. If you wish to enable it, see Section 5.7 for operation. With the access code enabled, any user can view parameter settings, but not change them. Note that this provides protection only against casual tampering. Use a lock on the cover latch if you need more protection.

4.5 Startup

Initial Startup

After having mounted the enclosure and wired the unit, the controller is ready to be started.

Plug in the controller and turn on the power switch to supply power to the unit. The display will briefly show the WEC model number and then revert to the normal summary display. Scroll through the menus and calibrate the conductivity reading, temperature, and set the control parameters detailed in Section 5, Operation.

When programming the controller for the first time, you must *follow the sequence listed below* to insure an accurate calibration:

- Set the Sensor Type (conductivity range) in the Sensor Menu for each sensor installed as described in Section 5.3.
- Set the desired units of measure in the Sensor Menu as described in section 5.2.
- Calibrate the temperature in the Temperature Menu as described in section 5.3.
- Set the temperature compensation percentage in the Temperature Menu as described in section 5.3.
- Set the Zero Adjust in the Sensor Menu to compensate for any offset introduced by the sensor or electronics. See Section 5.2.
- Calibrate the conductivity sensor in the Sensor Menu as described in section 5.2. You may choose either the one point or the multi-point calibration if you have selected % concentration as your units of measure.
- Set the control mode type in the CTRL 1-4 Menus prior to setting the set point values. See Section 5.4.

To return to the summary display, press the **EXIT** key until you return to this screen. The controller will automatically return to this screen after 10 minutes.

Normal Startup

Startup is a simple process once your set points are in memory. Simply check your supply of chemicals, turn on the controller, calibrate it if necessary and it will start controlling.

4.6 Shut Down

To shut the WEC controller down, simply turn off the power. Programming remains in memory.

5.0 OPERATION

These units control continuously while power is applied. Programming is accomplished via the local keypad and display.

To view the top level menu, press any key. The menu structure is grouped by inputs and outputs. Each input has its own menu for calibration and unit selection as needed. Each output has its own setup menu including set points, timer values, direction of control, etc. as needed. After ten minutes of inactivity in the menu, the display will return to the summary display. Keep in mind that even while browsing through menus, the unit is still controlling.

5.1 Main Menu

The exact configuration of your WEC/WDEC controller determines which menus are available as you scroll through the settings. Certain menus are only available when you select certain options, which may be hardware options (like the installation of a 4-20 mA output board) or software options (like choosing the units of measure as % concentration) or both. All settings are grouped under the following main menu items.

Sensor	Sensor A and Sensor B menus appear if the 2 nd sensor input card is installed (WDEC models)
Temperature	Temperature A and Temperature B menus appear if the 2 nd sensor input card is installed (WDEC models)
Control 1	
Control 2	
Control 3	
Control 4	
Interlock A	Only appears if the 2 nd sensor input card is installed (WDEC models)
Time	
4-20mA 1	Only if 4-20mA option installed
4-20mA 2	Only if 2nd 4-20mA option installed
Access Code	
Datalog	Only if advanced USB feature is in model code
Config	Only if advanced USB feature is in model code
Upgrade	

The **NEXT** key travels forward through this list while the **PREV** key travels backwards through the list. Pressing **ENTER** will Enter the lower level menu that is currently displayed.

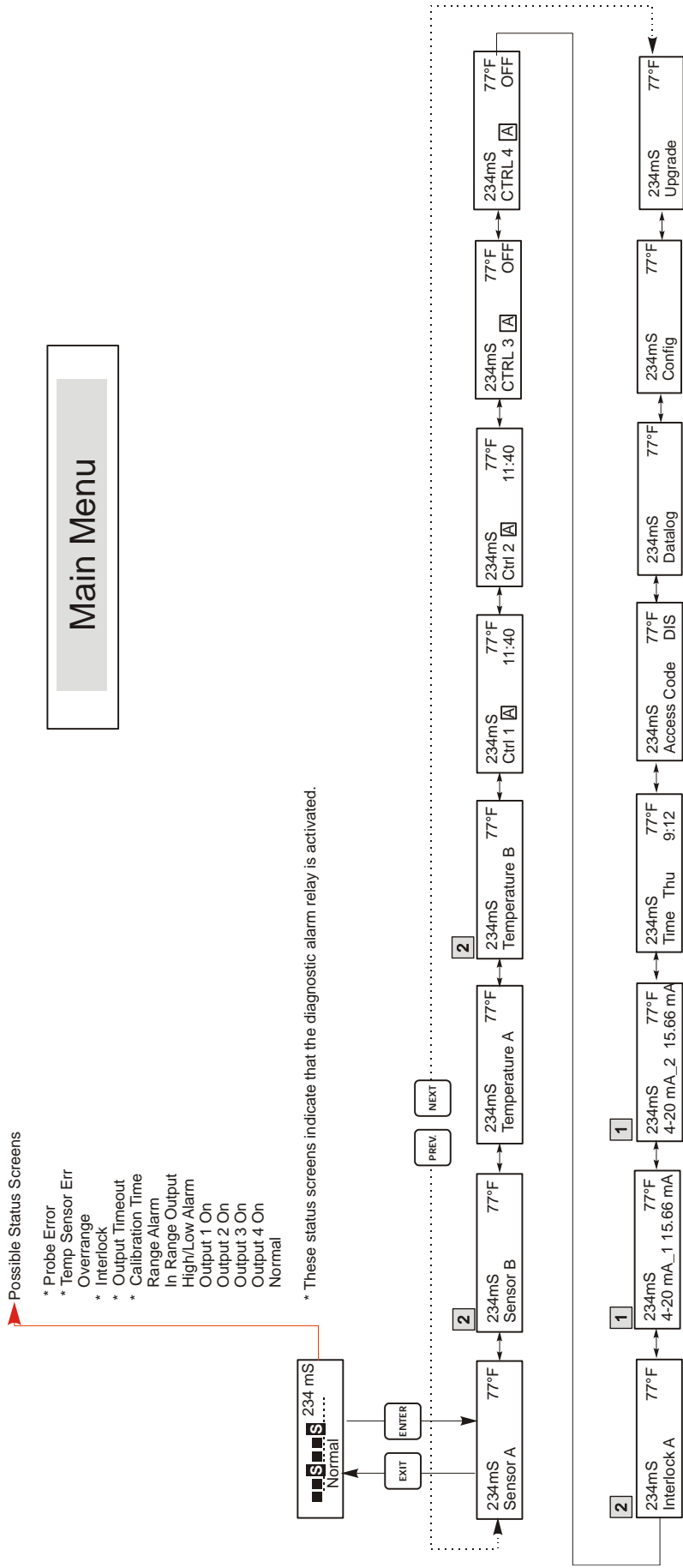

Legend

- 1 4-20mA menu is only present if 4-20mA option is installed.
- 2 Only present in WDEC models.

Operation

- Press Enter key to enter menu or submenu.
- Press Exit key to exit menu.
- After 10 minutes of inactivity the controller will automatically return to the summary screen.

Figure 7 Main Menu

5.2 Sensor Menu

The sensor menu provides the following settings: Calibration history (informational only), 2 point calibration, 1 point calibration, sensor type (range) selection, and other calibration menus. Each is discussed in detail below. Refer to the Sensor Menu chart on the next page.

Note: If you are programming the unit for the first time, press the **PREV** key once, and set the "Sensor Type" menu first to choose the range that matches the sensor you have connected. Then press **ENTER**.

Cal'd	Displays the date of the last sensor calibration.
1 Pt Calibration	<p>This menu is used to calibrate the sensor and controller to restore accuracy. There are a few options for how this can be accomplished:</p> <p>For units of measure of conductivity or ppm:</p>
	<p>Using a calibration standard: Rinse off the sensor and place it in a calibration solution of a known conductivity or ppm that is close to the same as your process solution. If the temperature of the standard solution is much different from the working solution temperature, allow it to equalize. This may take as long as 15 minutes. Press ENTER at the 1 Point Cal screen. The display will show a conductivity or ppm reading. If this does not match the known conductivity or ppm, use the arrow keys to change the displayed value and press ENTER. This method will not be very accurate unless the container of standard solution closely approximates the process solution dimensions and materials.</p>
	<p>Using a calibrated conductivity or TDS meter: Rinse off the sensor and place it in a sample of the process solution that has been measured with a previously calibrated conductivity or TDS meter. This may be the normal process installation location, if the conductivity is not changing quickly at the time. Press ENTER at the 1 Point Cal screen. The display will show a conductivity or ppm reading. If this does not match the known conductivity or ppm, use the arrow keys to change the displayed value and press ENTER.</p> <p>NOTE: When doing a manual calibration, be sure to use a container large enough to insure that the sensor is surrounded by at least 2 inches of liquid on all sides. Suspend the sensor; do not let it rest on the bottom of the container.</p> <p>WARNING! Do not attempt to perform a one point calibration with the sensor in free air. The range of calibration correction is 0.5 to 2.0. If the initial reading is not within this band, you will not be successful. Re-examine your connections and/or retest your sample liquid.</p>
Zero Adjust	<p>For units of measure of % concentration:</p> <p>The sensor calibration should be performed in the process solution at a time when the bath is not being used and is of a stable concentration. Leave the sensor in the process solution, at its normal operating concentration and temperature. Perform a laboratory analysis of the % concentration of the bath. Press ENTER at the 1 Point Cal screen. The display will show a % concentration reading. If this doesn't match the laboratory analysis, use the arrow keys to change the displayed value and press ENTER to update the calibration.</p> <p>This menu is used to calibrate the sensor to read precisely zero when it is dry. It should be set at installation with dry sensor in air. This zero procedure should be repeated if the range is changed or a new sensor is installed.</p> <p>Press ENTER to start the zero adjust procedure. When asked "Sensor in air?", remove the sensor from the process bath and dry it off. Use the arrow key to change the "N" to "Y" and press ENTER. You will be asked to press ENTER when the reading on the top line is stable. If the sensor offset was less than $\pm 20\%$ of full scale, the display will flash "Cal Successful" and return to the zero adjust display. You may now press EXIT.</p> <p>If the message "BadZero: CalFail" appears, the offset was too large for the software to compensate. Check to see that the sensor is out of the bath and is dry and that all wiring connections are correct. If none of these corrects the problem, install a new sensor.</p>

Multi Pt Cal	<p>WARNING! If you enter the multi-point calibration sequence and try to exit prematurely, the existing calibration constants will be erased. You will return to 100% as full scale.</p> <p>A multi-point calibration menu will only appear if the controller has been set up to display units of measure of % concentration. Many chemicals do not have a linear relationship between conductivity and % concentration. If the % concentration will be controlled within a narrow range ($\pm 5\%$ or so), then the 1 point calibration will be sufficient. If the accuracy experienced is not sufficient, then perform a multi-point calibration.</p> <p>The multi-point calibration will create linear segments between each two data points that it is given. The more points used, the better the calibration will fit the actual curve.</p> <p>Before performing a multi-point calibration, you will need to prepare as many calibration standards as you plan calibration points. These standards should be in containers large enough to hold the sensor with at least 2 inches around all sides, including top and bottom. You will also need a rinse bath of DI water.</p> <p>To start the calibration press ENTER when Multi Point Cal is displayed on the bottom line in the Conductivity A or B menu.</p>
Days Btwn Cal	<p>Use the arrow keys to set the number of days that you would like to go by before recalibrating the sensor. The controller will prompt you to recalibrate when that time has expired. Setting the number of days to zero will disable this feature.</p>
Units	<p>This menu is used to select the desired units of measure. Which units of measure are available depends upon the range selected. For ranges less than 10,000 $\mu\text{S}/\text{cm}$, the choices are $\mu\text{S}/\text{cm}$, ppm, and % concentration. For ranges above 10,000 $\mu\text{S}/\text{cm}$, the choices are mS/cm and % concentration.</p> <p>Press ENTER to change the units of measure. Use the up or down arrow keys to scroll through the available options. Press ENTER again when the desired choice is displayed. The controller will then display Warning, Check Set Points since all set points will still be the same value as they were before changing the units of measure. The controller does not convert the set points from the previous units to the current units of measure. Press ENTER again to clear this display warning.</p>
PPM CF	<p>This menu will only appear if the units of measure is selected to be ppm. Use the arrow keys to change the conversion factor to be used (to convert between $\mu\text{S}/\text{cm}$ and ppm) so that it matches your process bath. The preset value of 0.667 is a good starting point. Press ENTER to accept the change.</p>
Sensor mV	<p>This menu displays the mV from the sensor. It is useful for troubleshooting.</p>
Self Test	<p>Press ENTER to perform a self-test. If it says "FAIL" in the upper right hand corner, this indicates a problem with the controller which should be returned for repair. If it passes, and you have a problem calibrating, it is a sensor or wiring problem.</p>
Sensor Type	<p>Press ENTER to set up the controller to match the type of sensor to be used. Use the Up and Down arrows to toggle between 1 mS, 10 mS, 100 mS, and 1000 mS range, then press ENTER to make your selection.</p>
Damping	<p>This menu is used to set the desired amount of software damping of the conductivity sensor signal, in order to prevent rapid fluctuations in the reading. If you are seeing large changes in the conductivity reading, increase the damping until the reading is stable.</p> <p>Press ENTER to change the damping. Use the UP or Down arrow keys to scroll through the available options. Press ENTER again when the desired choice is displayed.</p>

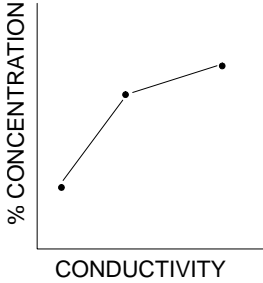
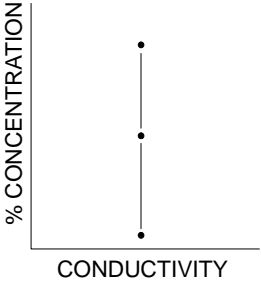
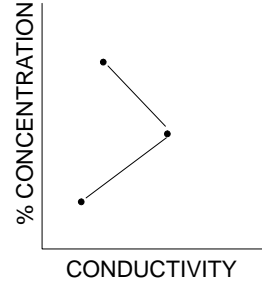
<p>Number of Pts</p>	<p>Use the arrow keys to set the desired number of calibration data points to use. As many as 5 data points may be programmed. Press ENTER to continue. You will need to prepare that number of samples, and perform laboratory analyses to determine the % concentration of each. At a minimum, you should use samples at the low end of the expected range, at the nominal value, and at the high end of the expected range. Selecting 0 or 1 data points will delete the existing multi-point calibration table.</p>
	<div style="display: flex; justify-content: space-around; align-items: center;"> <div style="text-align: center;"> <p>SUCCESSFUL CALIBRATION</p>  </div> <div style="text-align: center;"> <p>FAILED CALIBRATIONS</p> <div style="display: flex; justify-content: space-around;"> <div style="text-align: center;">  </div> <div style="text-align: center;">  </div> </div> </div> </div>
	<p>The display will then prompt you to Rinse Sensor. Rinse the sensor in DI water and press ENTER.</p>
	<p>Put in 1st soln, % conc is 100 will then be displayed. Use the arrow keys to change the % concentration to the value of the laboratory analysis, then press ENTER.</p>
	<p>Cond A #####µS/cm, ENTR when stable will then be displayed. When the numbers that are on the top line stabilize, press ENTER. Allow at least 3 minutes to insure temperature stabilization of the sensor.</p>
	<p>The display will prompt you again to Rinse Sensor. Rinse the sensor in DI water and press ENTER.</p>
	<p>Repeat the above procedures for each additional data point.</p>
	<p>After the last data point, the controller will either display Cal Successful or Cal Failure. A calibration will fail if there is no change in the readings for the various data points, or if the curve would result in the same reading applying to more than one data point.</p>
	<p>If the calibration is successful, press ENTER and the display will read Continue Y. This gives you time to replace the sensor in its process location before control resumes. Once the sensor is back in place, press ENTER to resume control of the process.</p>
	<p>WARNING! If you change scales, your calibration table will be deleted. Be sure you have selected the correct scale to cover the total range of your process liquid conductivity before entering your calibration values.</p>

Sensor Menu

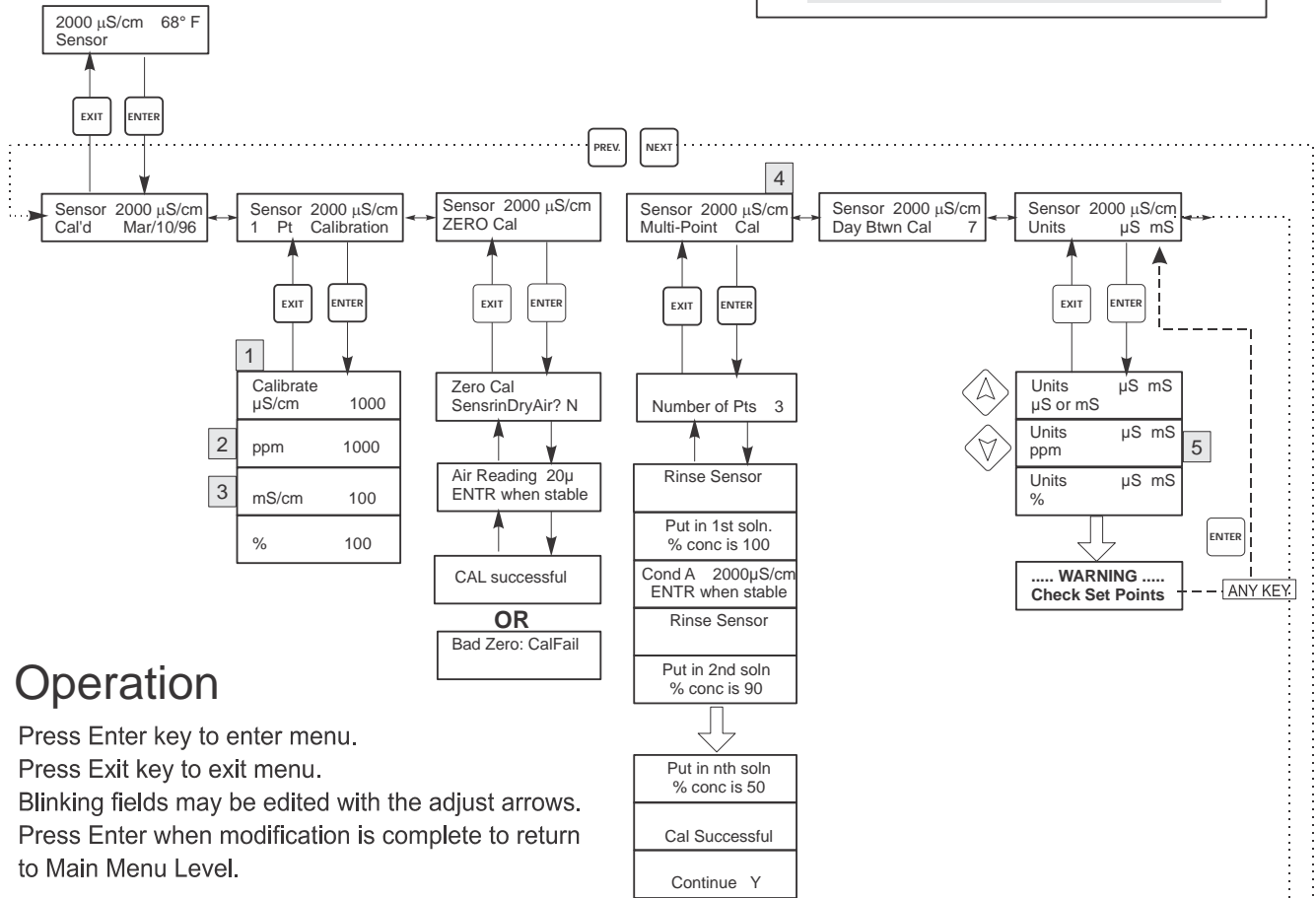

Operation

Press Enter key to enter menu.
 Press Exit key to exit menu.
 Blinking fields may be edited with the adjust arrows.
 Press Enter when modification is complete to return to Main Menu Level.

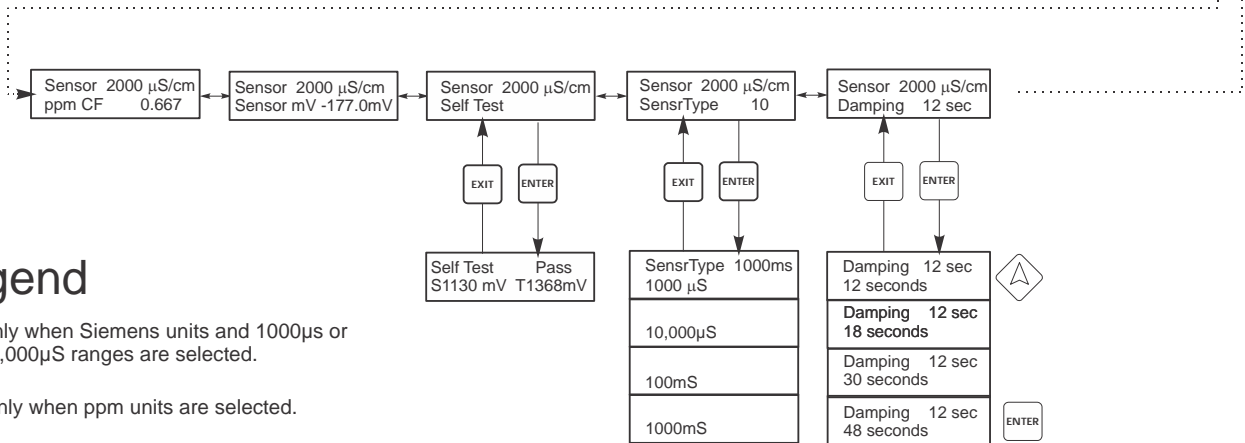

Legend

- 1 Only when Siemens units and 1000 μ S or 10,000 μ S ranges are selected.
- 2 Only when ppm units are selected.
- 3 Only when Siemens units and 100mS or 1000mS ranges are selected.
- 4 Only when % units are selected.
- 5 Only when 1000 μ S or 10,000 μ S ranges are selected.

Figure 8 Sensor Menu

5.3 Temperature Menu

The temperature menu contains the following settings: Calibrate and Units (if the Pt100K sensor is detected when the unit is powered on) or Manual Temp and Units (if no Pt100K sensor is detected at power-up). Refer to the Temperature Menu chart below.

Calibrate	To Calibrate the Temperature, use a thermometer to measure the fluid temperature and adjust the WEC controller to match. Once Calibrate is entered, the unit continuously displays temperature readings. Press the Up or Down arrow key to change the value displayed to match the thermometer. You must press ENTER to activate the new calibration. You must press the EXIT key to exit calibration.												
Man Temp	This menu appears only if no temperature element is connected at power-up. Use the arrow keys to adjust the temperature displayed to match that of the water.												
Units	You may choose to display temperature in °C or °F. Press ENTER and the Up or Down Arrow keys to change the temperature units for display.												
Temp Comp %	<p>This menu is used to set the automatic temperature compensation factor. The normal value for water is 2% per degree C. Different chemicals will have different errors with changing temperature.</p> <p>If you do not know what the temperature related error will be for your chemistry, follow this procedure to determine it:</p> <p>Set the Temp Comp % menu item to 0.00%</p> <p>Take a sample of your operating solution at its normal concentration and 25°C (78°F). Measure the conductivity in the cool sample and note the temperature measured by the controller. Heat it to normal operating temperature, making sure to maintain the original volume by replacing any evaporated water. Allow 10 minutes for the sensor to reach the same temperature as the sample. Note the conductivity and measured temperature of the heated sample.</p> <p>If the conductivity is no longer the same as it was at room temperature, then calculate the temperature compensation factor using this formula:</p> <table border="1" style="width: 100%; text-align: center;"> <tr> <td colspan="2">Correction = in percent $(\text{Cond}_{\text{AMB}} - \text{Cond}_{\text{OPR}}) \times 100$</td> </tr> <tr> <td colspan="2">$\frac{\text{Cond}_{\text{OPR}} (T_{\text{AMB}} - 25) - \text{Cond}_{\text{AMB}} (T_{\text{OPR}} - 25)}{\text{Cond}_{\text{OPR}} (T_{\text{AMB}} - 25) - \text{Cond}_{\text{AMB}} (T_{\text{OPR}} - 25)}$</td> </tr> <tr> <td>where:</td> <td>Cond_{AMB} = Conductivity at room temperature</td> </tr> <tr> <td></td> <td>Cond_{OPR} = Conductivity at operating temperature</td> </tr> <tr> <td></td> <td>T_{OPR} = Operating temperature</td> </tr> <tr> <td></td> <td>T_{AMB} = Room temperature</td> </tr> </table> <p>Note that in the equation denominator Cond_{OPR} s multiplied by T_{AMB} and Cond_{AMB} is multiplied by T_{OPR}.</p> <p>Return to the Temperature menu, Temp Comp %, and use the arrow keys to enter this new value.</p>	Correction = in percent $(\text{Cond}_{\text{AMB}} - \text{Cond}_{\text{OPR}}) \times 100$		$\frac{\text{Cond}_{\text{OPR}} (T_{\text{AMB}} - 25) - \text{Cond}_{\text{AMB}} (T_{\text{OPR}} - 25)}{\text{Cond}_{\text{OPR}} (T_{\text{AMB}} - 25) - \text{Cond}_{\text{AMB}} (T_{\text{OPR}} - 25)}$		where:	Cond_{AMB} = Conductivity at room temperature		Cond_{OPR} = Conductivity at operating temperature		T_{OPR} = Operating temperature		T_{AMB} = Room temperature
Correction = in percent $(\text{Cond}_{\text{AMB}} - \text{Cond}_{\text{OPR}}) \times 100$													
$\frac{\text{Cond}_{\text{OPR}} (T_{\text{AMB}} - 25) - \text{Cond}_{\text{AMB}} (T_{\text{OPR}} - 25)}{\text{Cond}_{\text{OPR}} (T_{\text{AMB}} - 25) - \text{Cond}_{\text{AMB}} (T_{\text{OPR}} - 25)}$													
where:	Cond_{AMB} = Conductivity at room temperature												
	Cond_{OPR} = Conductivity at operating temperature												
	T_{OPR} = Operating temperature												
	T_{AMB} = Room temperature												

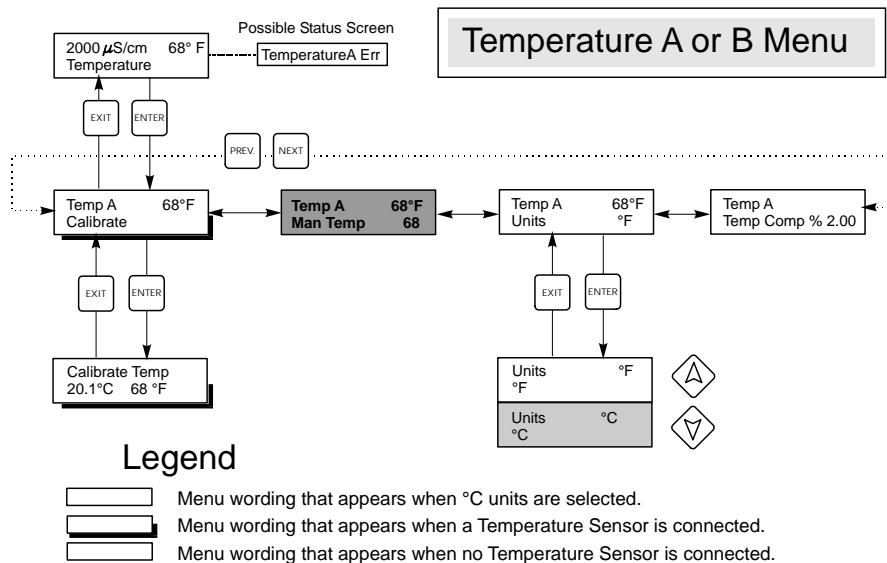

Figure 9 Temperature Menu

5.4 Control 1 - 4 Menus

The Control 1 - 4 menus are separate from each other but operate in exactly the same way. Each menu provides the following independent settings: Set Point, Dead Band, Time Limit, Interlock, Output Mode, Assign Input, HOA, Set Point, Dead Band, and Time Limit. The Control menu will be indicated on the display by one of the following: (The 'A' indicates that the output is being controlled automatically.)

NOTE: When programming the unit for the first time, go to the “Mode” menu to select how that output will operate. Making this assignment first will bring up the correct menus for the Mode you are using.

Ctrl 1 A	OFF	Indicates that the output is currently OFF.
Ctrl 1 A	10:00	Indicates the length of time that the output has been ON.
Ctrl 1 A	Intrck	Indicates that control has been suspended because the Interlock switch is Open
Ctrl 1 A	TIMEOUT	Indicates that the output has been on longer than the Time Limit.

Mode	Press the ENTER key to change the mode in which the output will operate. The relays may be a low set point, a high set point, a low alarm, a high alarm, an out-of-range alarm, an in-range output. Use the arrow keys to scroll through the choices.
	Low Set Point Press ENTER when this is displayed to select a low set point. The relay will close when the process value goes below the set point value. The summary screen will display that the output is on. A time limit menu will be available, to prevent runaway control. An Interlock menu will be available to allow you to stop control if flow past the sensor stops.
	High Set Point Press ENTER when this is displayed to select a high set point. The relay will close when the process value goes above the set point value. The summary screen will display that the output is on. A time limit menu will be available, to prevent runaway control. An Interlock menu will be available to allow you to stop control if flow past the sensor stops.
	Low Alarm Press ENTER when this is displayed to select a low alarm. The relay will close when the process value goes below the set point value. The summary screen will display “Low Alarm”. No time limit or interlock features will be available.
	High Alarm Press ENTER when this is displayed to select a high alarm. The relay will close when the process value goes above the set point value. The summary screen will display “High Alarm”. No time limit or interlock features will be available.
	Out Range Alarm Press ENTER when this is displayed to select an out-of-range alarm. The relay will close when the process value is either above or below the two set point values. The summary screen will display “Range Alarm”. No time limit or interlock features will be available.
	In Range Output Press ENTER when this is displayed to select an in-range output. The relay will close when the process value is between the two set point values. The summary screen will display “In Range Output”. No time limit or interlock features will be available.

Mode (Continued)	Time Prop Hi Press ENTER when this is displayed to use time proportional control with a high set point. In Time Proportional Mode, the farther away from the set point the system is, the longer the ON time. Refer to the drawings below for an illustration of Time Proportional Mode.
	Time Prop Lo Press ENTER when this is displayed to use time proportional control with a low set point. In Time Proportional Mode, the farther away from the set point the system is, the longer the ON time. Refer to the drawings below for an illustration of Time Proportional Mode.
Low Set Point	Only appears if the Mode is Low Set Point or Time Prop Lo Press ENTER if you want the Control relay to close if the process goes below a certain value. The status screen message will be Output ON. This denotes a normal correction of the process value. If you want the status message to be Low Alarm, indicating a problem, choose an Output Mode of Low Alarm as described below.
High Set Point	Only appears if the Mode is High Set Point or Time Prop Hi Press ENTER if you want the Control relay to close if the process above a certain value. The status screen message will be Output ON. This denotes a normal correction of the process value. If you want the status message to be High Alarm, indicating a problem, choose an Output Mode of High Alarm as described below.
Low Alarm	Only appears if the Mode is Low Alarm, In Range or Out of Range Press ENTER if you want the Control relay to close if the process goes below a certain value. The status screen message will be Output ON. This denotes a normal correction of the process value. If you want the status message to be Low Alarm, indicating a problem, choose an Output Mode of Low Alarm as described below.
High Alarm	Only appears if the Mode is High Alarm, In Range or Out of Range Press ENTER if you want the Control relay to close if the process above a certain value. The status screen message will be Output ON. This denotes a normal correction of the process value. If you want the status message to be High Alarm, indicating a problem, choose an Output Mode of High Alarm as described below.
Dead Band	<p>Use the arrow keys to set the desired dead band, then press ENTER. If the set point is 50 mS, and the dead band is 0.5 mS, then the relay will close at 50 mS and open 0.5 mS away from 50.</p>

<h2>Proportional Band</h2>	<p>This menu only appears if Time Proportional control mode is selected.</p> <p>The proportional band menu sets the deviation from set point at which the control output will be on for the entire sampling period.</p> <p>The volume added at the worst case deviation can be calculated by multiplying the pump flow rate by the sample period time (for example, 1 gal per minute flow rate x 2 min sample period = 2 gal of chemical added). Then calculate the effect on the concentration of this addition (for example, if a 2 gal addition will raise the reading by 0.5 then the proportional band should be set to 0.5).</p> <p>If the proportional band is set too low, then the controller could overshoot the set point. If it is set too high, then the controller may never be able to reach the set point.</p>								
	<p>Figures below show an example of Time Proportional Mode with the following program parameters:</p> <table border="0"> <tr> <td>Control Mode</td> <td>Time Prop Hi</td> </tr> <tr> <td>Sample Period</td> <td>10 minutes</td> </tr> <tr> <td>High Set Point</td> <td>300 mS</td> </tr> <tr> <td>Proportional Band</td> <td>50 mS</td> </tr> </table>	Control Mode	Time Prop Hi	Sample Period	10 minutes	High Set Point	300 mS	Proportional Band	50 mS
Control Mode	Time Prop Hi								
Sample Period	10 minutes								
High Set Point	300 mS								
Proportional Band	50 mS								
	<p>In the example figures, the set point is 300 and the Proportional Band is 50. Note that when the conductivity goes above the set point, the control relay is ON for a short period of time. As the conductivity increases, the control relay is ON for a longer period of time. When the addition starts to affect the bath concentration and the conductivity is reduced, the control relay is ON for a shorter period of time. When the conductivity drops below the set point of 300, the control relay is OFF all the time.</p>								
<h2>Sample Period</h2>	<p>This menu only appears if Time Proportional control mode is selected.</p> <p>It allows setting the sampling period from 0 to 30:00 minutes. This is the time that will elapse between checking the sensor input reading for deviation from set point. The Proportional Band setting and how far the current reading is from the set point will determine the amount of time that the relay remains on.</p> <p>The sample period should be set to approximately 1½ times the amount of time that it takes for the sensor to react to an addition of chemical. This can be determined by making a manual addition of chemical using the HOA menu and timing how long it takes for the controller to react.</p> <p>Setting the sample period too low will result in a second addition being made before the first is detected and you will overshoot the set point. Setting too high will delay the next addition to the point that the set point may never be reached.</p>								
<h2>Time Limit</h2>	<p>This menu only appears if the output mode has been selected as a Low Set Point, or a High Set Point.</p> <p>Use the arrow keys to set the time limit (min:sec) for the output to be active, then press ENTER. If it is set for "0:00", no limit will be imposed, and the output could stay on forever.</p>								

Reset Timer	This menu only appears if the output mode has been selected as a Low Set Point, or a High Set Point and the time limit has expired. Determine the reason that the output stayed on too long, and once the problem has been solved, press ENTER to reset the timer.
Assign Input	This menu only appears in WDEC dual input models. Press the ENTER key to change the sensor signal which will be used to control the output. Use the arrow keys to toggle between Sensor A and Sensor B. Press ENTER to accept the change
Interlock	Use the Up and Down arrows to toggle between Y(Yes) and N(No). Choosing Y means that the output will deactivate if the device attached to the controller is open. For example, if the sensor is installed in a recirculating pipe line, a flow switch that is closed if flow is sufficient and open if flow is insufficient may be installed in the line, so that if flow past the sensor stops, the controller will not pump in chemicals based on a stagnant sample. Similarly, a level switch may be attached to prevent control of an empty batch tank.
HOA	Use the Left and Right arrows to move between Hand, Off and Auto. In Hand (Manual) mode, the output will be turned on immediately for a maximum of 10 minutes. In the Off mode, the output will be turned off indefinitely. In the Auto mode, the output turns on and off in response to changes in the process value relative to the set point. The letter inside the block on the status screen indicates which mode the output is in.

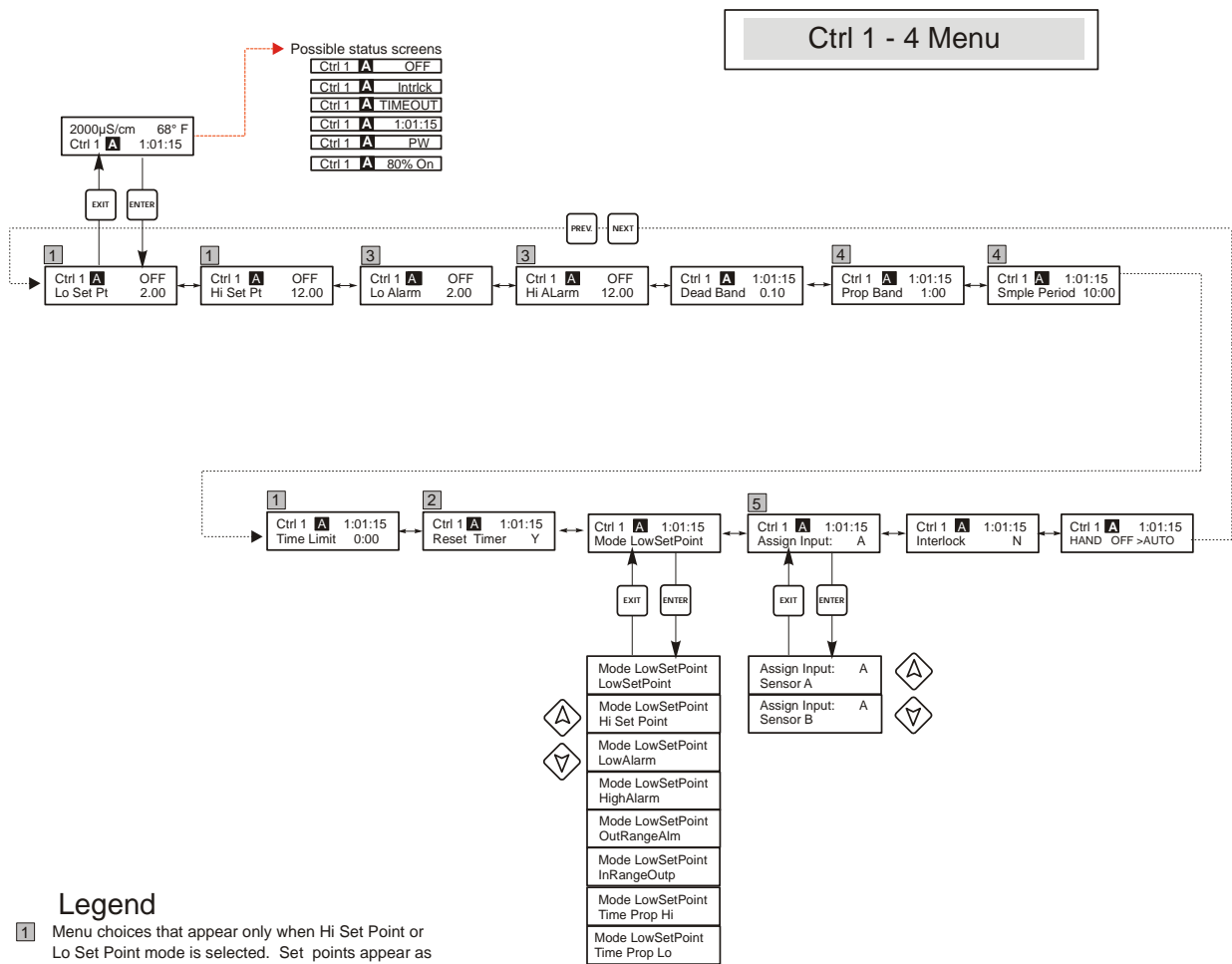

Operation

Press Enter key to enter menu.
 Press Exit key to exit menu.
 Blinking fields may be edited with the adjust arrows.
 Press Enter when modification is complete to return to Main Menu Level.

Figure 10 Control 1 - 4 (On/Off) Menu

5.5 Interlock A Menu

This menu only appears in WDEC models.

The Interlock A menu is used to assign an interlock device to the appropriate sensor. An interlock device is an external monitoring sensor like a flow or level switch that serves to deactivate control outputs when activated. For example, this could be used to prevent the controller from pumping chemicals based on a stagnant sample.

The WDEC controller can support up to two interlock devices. Refer to Figure 3b for a wiring illustration. A typical setup would use one flow switch for sensor A and one for sensor B and they would function independently. This is the default setting and describes operation when **Sensor A Only** is selected in this menu.

However, in some applications it is desirable to have one interlock device assigned to both sensor A and B. For example, if you have both sensors mounted in the same sample stream, then a flow switch input could be used to disable control for both sensors. This describes the operation when **Sensor A and B** is selected in this menu. *Note: If this type of operation is desirable, the single interlock device must be connected to the Sensor A input as illustrated in Figures 3b.*

To make a selection, press **ENTER** at the Interlock A menu. Use the UP or Down keys to toggle between **Sensor A Only** and **Sensor A + B**. Press **ENTER** again when the desired choice is displayed to change the selection. Press **EXIT** to return to the higher level menu.

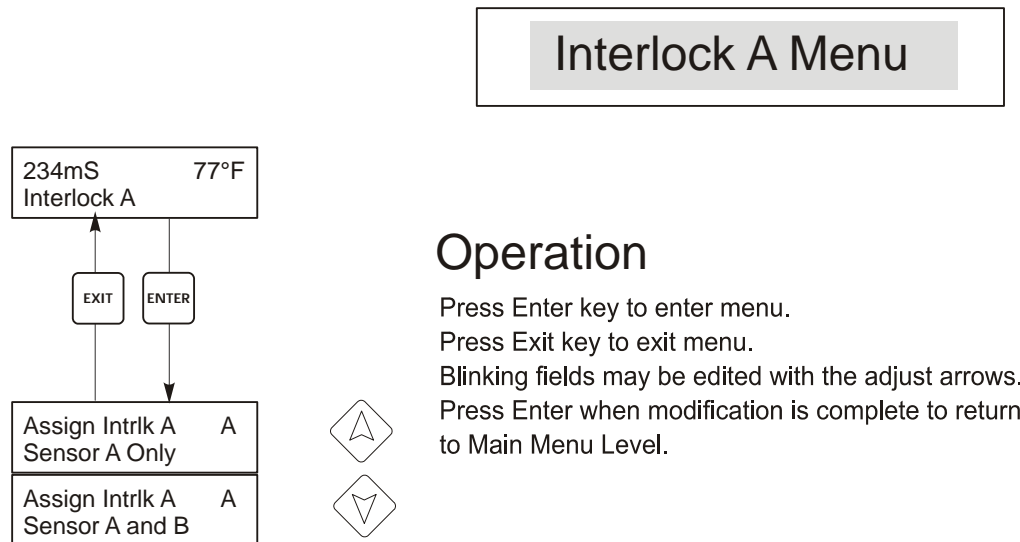

Figure 11 Interlock A Menu

5.6 4-20 mA 1 and 2 Menus (Optional)

These menus will only appear if the optional 4-20 mA output board(s) is installed. They are used to set the scale of the 4-20 mA output. It contains the following menu selections: Assign Inputs, 4 mA Point, 20 mA Point, and Calibrate.

Note: When programming the controller for the first time, first go to the Assign Inputs Menu, then program the other menus.

Assign Inputs	Press ENTER to change the source of the signal to be converted to 4-20 mA between Cond A, Cond B, Temp A and Temp B (the B options are only available in WDEC models). Use the arrow keys to toggle between the choices. Press ENTER when the appropriate source is displayed.
4 mA Pt	Use the arrow keys to enter the process value (in the units selected in the Sensor menu) that you want to correspond to a 4 mA output from the controller.
20 mA Pt	Use the arrow keys to enter the process value that you want to correspond to a 20 mA output from the controller.
Calibrate	This menu is used to calibrate instruments connected to the mA output. The 4-20 mA output is extremely accurate and stable and therefore will never need calibration. This feature allows other devices to be calibrated at the 4 and 20 mA points. Press ENTER to start the calibration.
Fixed 4 mA Out	The controller will output 4.00 mA. Adjust the chart recorder or data logger per its instruction so that the process value displayed is what is expected for a 4.00 mA input.
Fixed 20 mA Out	As above, except that the controller will output 20.00 mA. The design of the 4-20 mA output is such that it should never need calibration. If the mA signal is not what it should be, call the factory for service.

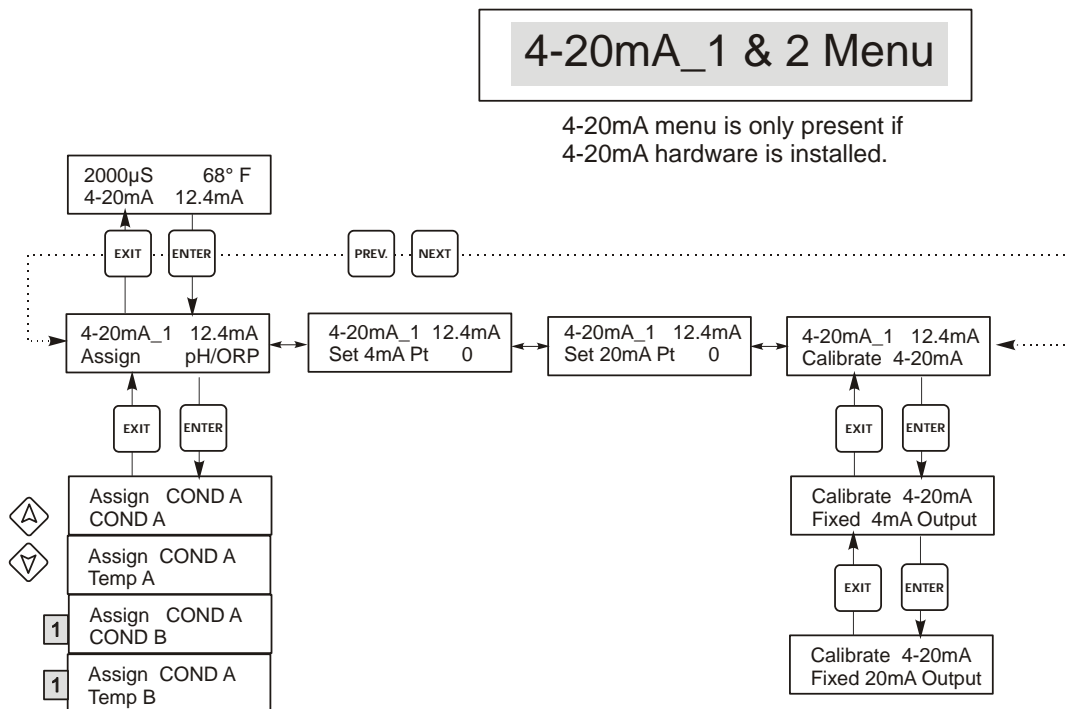

Legend

1 Only appears in WDEC models.

Figure 12 4-20 mA 1 and 2 Menus

5.7 Time Menu

The time menu is used to set the date and time that the controller uses for calibration prompts. There is only one menu selection: Set Clock.

<i>Set Clock</i>	Press ENTER to set the clock. Use the arrow keys to change the year, date, and month, then press ENTER . Use the arrow keys again to set the day of the week and the time. Use military time (for example, 1:00 PM is 13:00). Press ENTER to return to the top level clock menu.
------------------	-------------------------------------------------------------------------------------------------------------------------------------------------------------------------------------------------------------------------------------------------------------------------------------------------------

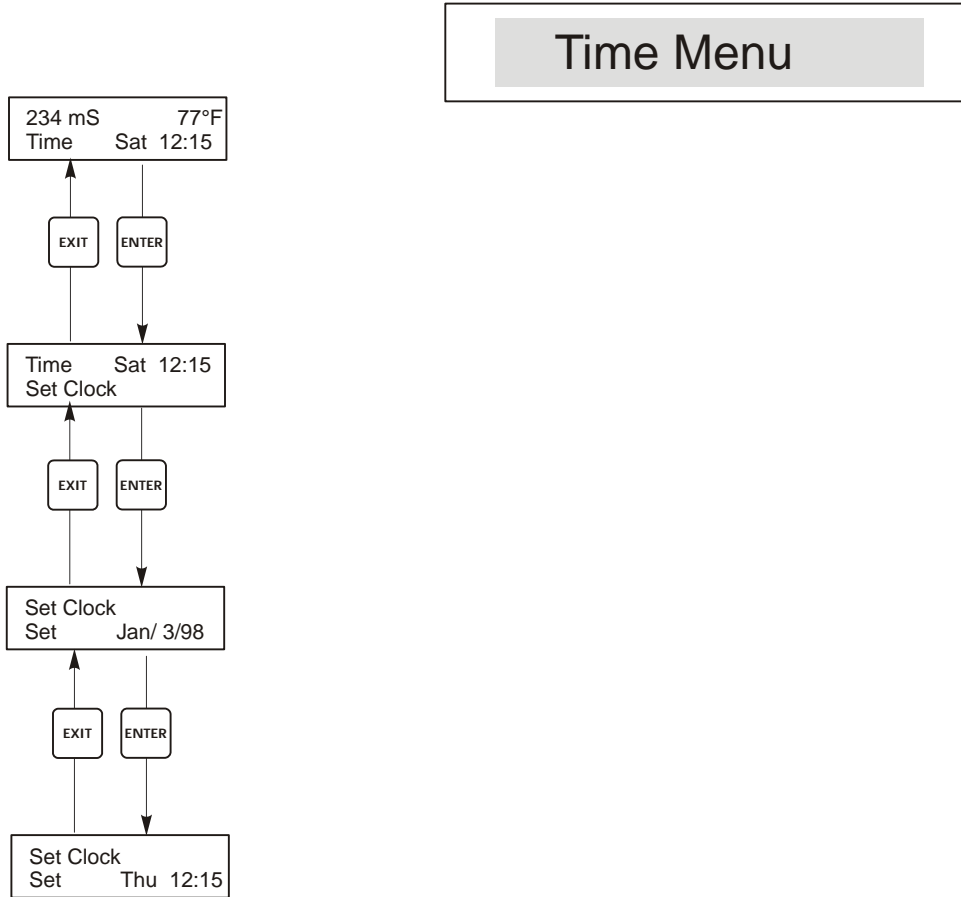

Figure 13 Time Menu

5.8 Access Code Menu

This menu determines whether the access code feature of the controller is enabled or disabled and allows you to customize the access code to your own value. The access code controls whether or not you are allowed to change the parameters in the controller. With the access code disabled, any user may change any parameter. With the access code enabled, any user can view any parameter, but cannot change them. Once an attempt is made to change a parameter, the display will prompt the user to enter the access code. If the correct access code is entered, the parameters can be changed. If the wrong access code is entered the parameters cannot be changed. Once the access code has been correctly entered, it will remain valid until there is a period of 10 minutes without a key being pressed. The access code menu will appear as shown below:

Access Code	DIS	Indicates that the access code is disabled. No access code is required to change any setting.
Access Code	REQ	Indicates that the access code is required to alter settings.
Access Code	OK	Indicates that the access code is required and has been entered correctly.

Enable N / Y	Press the Up or Down arrow key to change the N to Y and press ENTER to enable the access code feature. If the access code is enabled you must first enter the access code to disable it.
New Value	<p>Press ENTER to display the current access code value and use the arrow keys to change it to any value between 0 and 9999. If the access code has been enabled, you will be prompted to enter the current access code before being allowed to change it. You must remember the access code if you enable it.</p> <p>The Factory default Access code is 1995.</p> <p>If you change the access code and can't remember it follow this procedure:</p> <ol style="list-style-type: none"> 1. Turn off power to the controller. 2. Wait 10 seconds. 3. Press and Hold the UP and DOWN arrow keys while turning on the power. 4. Read the access code on the display. 5. Release the keys, and the access code will disappear.

Access Code Menu

Any Top Display
Access Code 0000

The Access Code prompt may appear at any screen in the entire menu structure if the current access code has not been entered by the user. Access code entries will be valid for 10 minutes from the most recent key press.

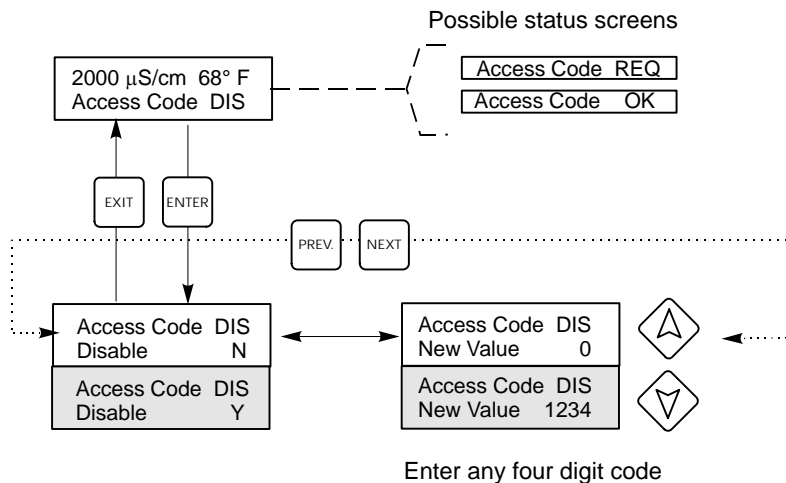

Figure 14 Access Code Menu

5.9 Datalog Menu

This menu is available if the data logging option has been purchased. This is indicated in the model code by the letter U at the end of the model code. This menu allows you to save data from the controller to a USB flash drive.

The controller has four logs, the Current Datalog, the Backup Datalog, the Event Log, and the Reset Log. All files are in a CSV format that may be opened in a spreadsheet such as Microsoft Excel.

Current Datalog	<p>Contains the following data taken at 10 minute intervals: Conductivity Temperature</p> <p>When the current datalog is downloaded to a USB stick, it is erased and a new log file is started. If the current datalog is not downloaded before it reaches its maximum size (at least 60 days of data) the oldest data is overwritten by the newest data.</p>	
Backup Datalog	<p>Contains the same data as the current log but it is never erased. When the backup log reaches its maximum size (at least 60 days of data), the oldest data is overwritten by the newest data.</p>	
Event Log	<p>Contains columns for each relay and flow switch input, as well as the date and time. Each time any of these change state, the date and time is updated and it will show a 1 if the relay is on and 0 if it is off, and a 1 if the flow switch indicates no flow, 0 if there is flow. Tens of thousands of events will be recorded before the oldest data is overwritten by the newest, the number varying with the controller's configuration.</p>	
Reset Log	<p>Consists of time stamps of when power was lost, when it was returned, and the cause of the reset.</p>	
Current or Backup Datalog	<p>Place a USB flash drive with at least 10 MB capacity into the USB port on the front panel of the controller. Press the Enter key to download the file from the controller to the disk. The file name for the Current Datalog will be Datalog<serial number><date><time>.csv using the date and time it was downloaded. The file name for the Backup Datalog will be Datalog<serial number><date><time>.csv using the date and time it was created.</p> <p>The controller will display the progress of the file download process. If the file was successfully copied to the USB disk the controller will display Transfer Success.</p>	
Copy Event Log	<p>Place a USB flash drive with at least 10 MB capacity into the USB port on the front panel of the controller. Press the Enter key to download the file from the controller to the stick. The file name will be Eventlog<serial number><date><time>.csv.</p> <p>The controller will display the progress of the file download process. If the file was successfully copied to the USB disk the controller will display Transfer Success, otherwise Transfer Fail 1.</p>	
	Transfer Success	Transfer Fail 1
Copy Reset Log	<p>Place a USB flash drive with at least 10 MB capacity into the USB port on the front panel of the controller. Press the Enter key to download the file from the controller to the stick. The file name will be Resetlog<serial number><date><time>.csv.</p> <p>The controller will display the progress of the file download process. If the file was successfully copied to the USB disk the controller will display Transfer Success.</p>	
	Transfer Success	Transfer Fail 1

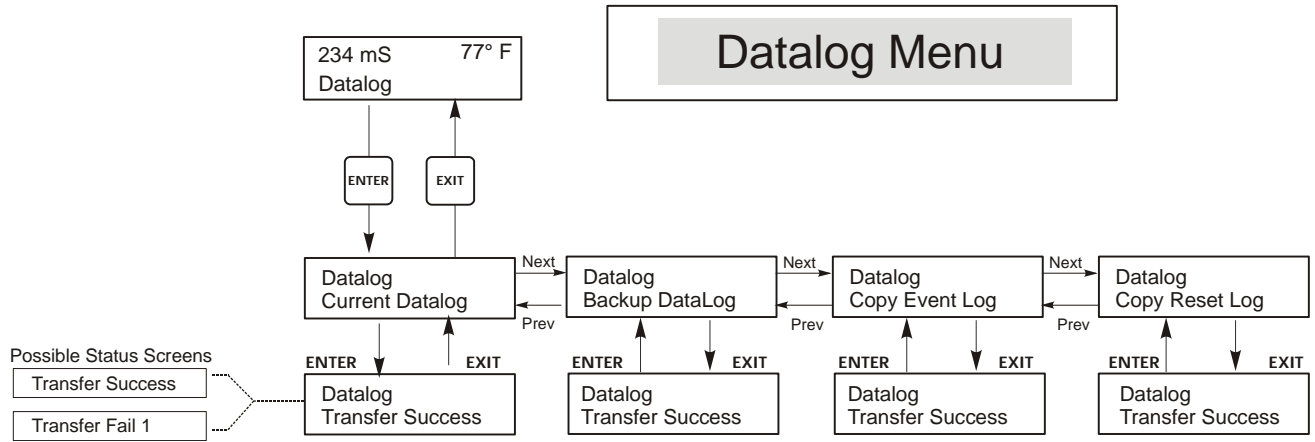

Figure 15 Datalog Menu

5.10 Config Menu

This menu allows you to export a file that contains all of the set points in the controller to a USB flash disk drive, and then later import the set points into another controller.

Export Config	Place a USB flash drive with at least 10 MB capacity into the USB port on the front panel of the controller. Press the Enter key to export the configuration file from the controller to the stick. The file name will be UCF.ini. If you are exporting files with different set points you may rename the file to something that describes it, as long as it has an ini extension.	
	The controller will display the progress of the file download process. If the file was successfully exported to the USB disk the controller will display Transfer Success, otherwise Transfer Fail 1.	
	Transfer Success	Transfer Fail 1
Import Config	Place a USB flash drive that contains only one configuration file stored on the root directory of the stick into the USB port on the front panel of the controller. Press the Enter key to import the configuration file from the stick to the controller. The file name must have an ini extension in its name.	
	The controller will display the progress of the file import process. If the file was successfully imported from the USB disk the controller will display one of the messages below:	
	Import Failure	Indicates that there were problems connecting to or accessing the USB stick.
	Import Success: Any key to reboot	The configuration file import succeeded and will be ready for use after reboot.
	File Open Failed	A config file could not be found on the USB stick or the USB stick file system could not be accessed.
	File Read Failed	The config file is too short (incomplete) or empty.
	Invalid CFG File	The imported file is not a valid config file.
	Invalid Model	The imported config file is not for this controller model.
	Wrong SW Version	The version of the imported config file is not compatible with this controller software version.
	Corrupt CFG File	The imported config file is corrupt. (The checksum failed.)
Wrong file Size	The size of the imported config file is wrong.	

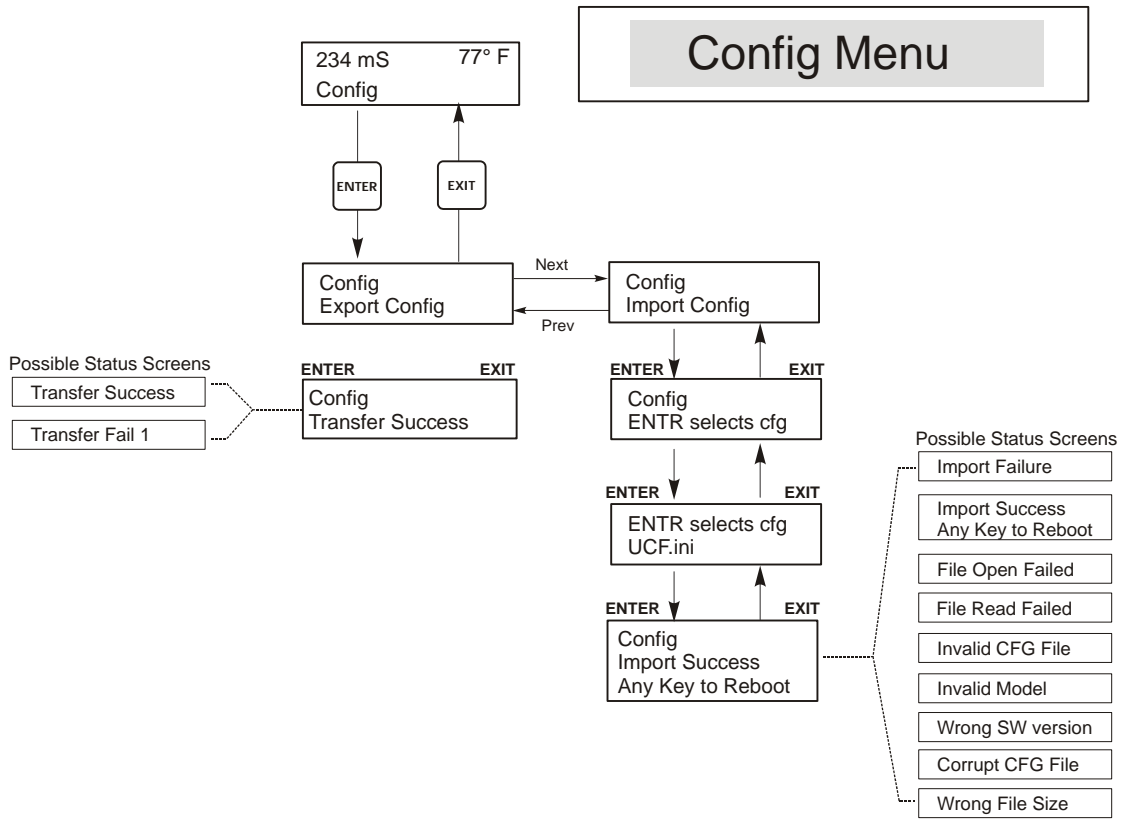

Figure 16 Config Menu

5.11 Upgrade Menu

This menu is used to upgrade the software to a newer version. If a new version of the software is available, an upgrade file will be posted on our web site. Save this file to a USB flash disk drive. It needs to be the only upgrade file stored on the root directory of the stick. Press the Enter key to import the software upgrade file from the stick to the controller.

The controller will display the progress of the file import process. If the file was successfully imported from the USB disk the controller will display Transfer Success. The controller will automatically reboot and come up with the new software installed.

Upgrade	The controller will display the progress of the file import process. If the file was successfully imported from the USB disk the controller will display Transfer Success. The controller will automatically reboot and come up with the new software installed. If the software upgrade fails, you will see one of the following messages:	
	UpgradFileInvalid	The file found on the USB stick is for the wrong product, or is corrupt. Try getting the correct upgrade file and make sure it's the only upgrade file on the stick.
	No Upgrade File	There is no upgrade file stored on the stick, or the file is named incorrectly.
	CorrptUpgradFile	Try getting a new copy of the file.
	Flash Failure	The flash memory on the processor board has a problem. Repair or replace the front panel assembly.

To check that it was successful, turn off power to the controller, then press the Enter key while turning power on. The controller will show the software version, which should match the name of the upgrade file that you used.

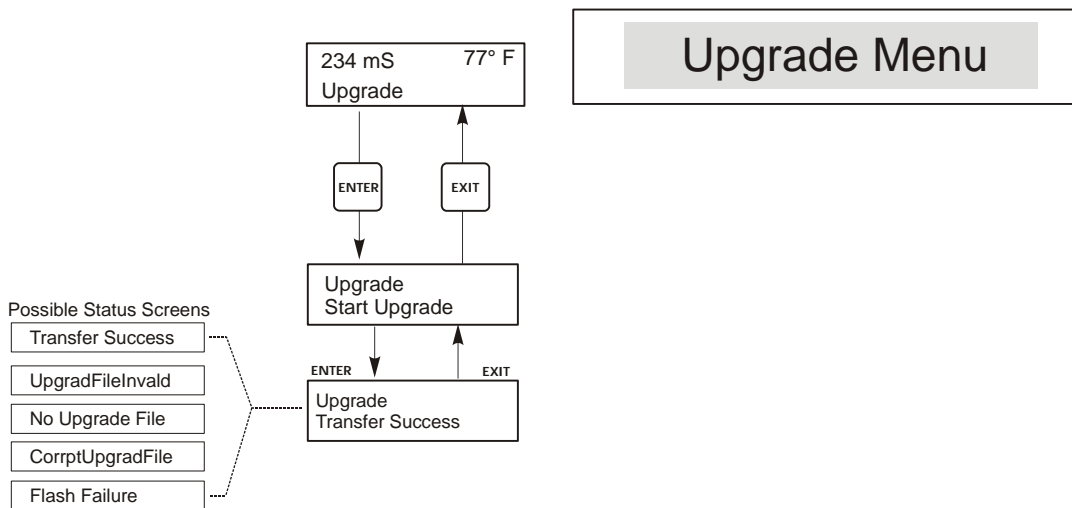

Figure 17 Upgrade Menu

6.0 MAINTENANCE

The WEC control module itself needs very little maintenance. Clean the outside of the controller enclosure with a damp cloth. Do not spray down the controller unless the enclosure door is closed and latched. "Pigtails" should be protected from spray or wash-down. Check the cords and cables for damage.

6.1 Sensor Cleaning

NOTE: The controller must be recalibrated after cleaning the sensor.

Frequency

The sensor should be cleaned periodically. The frequency required will vary by installation. In a new installation, it is recommended that the sensor be cleaned after two weeks of service. To determine how often the sensor must be cleaned, follow the procedure below.

1. Read and record the conductivity.
2. Remove, clean and replace the conductivity sensor.
3. Read conductivity and compare with the reading in step 1 above.

If the variance in readings is greater than the accuracy you require, increase the frequency of sensor cleaning. If it is less than the accuracy you require, the probe was not dirty and can be cleaned less often.

Cleaning Procedure

An accumulation of dirt or debris on the sensor can effect the accuracy and the thermal time constant. This accumulation should be removed periodically. This can be accomplished by scrubbing with a toothbrush or stiff bottle brush. Soap or hand cleaner may help. Harsh abrasives should be avoided. Rinse the sensor thoroughly before returning to service.

6.2 Replacing the Fuses



CAUTION: Disconnect power to the controller before opening front panel!

Locate the fuses on the circuit board at the back of the controller enclosure. (See figure 4.) Gently remove the old fuse from its retaining clip and discard. Press the new fuse into the clip, secure the front panel of the controller and return power to the unit.

Warning: Use of non-approved fuses can affect product safety approvals. Fuse ratings depend on controller power rating. Specifications are shown below. To insure product safety certifications are maintained, it is recommended that a Walchem fuse be used.

F1 Fuse	Walchem P/N	F2 Fuse	Walchem P/N
5 x 20 mm, 1.0A, 250V	103163	5 x 20 mm, 6A, 250V	102834

7.0 TROUBLESHOOTING



CAUTION: Disconnect power to the controller before opening front panel!

Troubleshooting and repair of a malfunctioning controller should only be attempted by qualified personnel using caution to ensure safety and limit unnecessary further damage. Contact the factory.

7.1 Error Messages

Output Timeout

This error message appears if one of the control outputs has been on longer than the maximum amount of time programmed in the "Time Limit" menu found in the Control menus. It is reset by answering "Yes" to the "Reset Timer" prompt that will appear or by cycling power to the controller off and back on. There are a number of possible reasons that the output could go on for longer than normal:

Possible Cause	Corrective Action
The process went further out of control than normal.	Increase time limit or reset timer.
The chemical supply has run out.	Replenish the chemical supply.
The pump or valve or supply line is faulty.	Repair or replace the control device.
Wrong chemical is being controlled.	Replace with correct chemical.
The sensor is not responding to changes.	Replace sensor, cable or preamplifier. Evaluate mixing or recirculation.

Bad Zero: Cal Fail

This error message appears if one of the control outputs has been on longer than the maximum amount of time programmed in the "Time Limit" menu found in the Control menus. It is reset by answering "Yes" to the "Reset Timer" prompt that will appear or by cycling power to the controller off and back on. There are a number of possible reasons that the output could go on for longer than normal:

Possible Cause	Corrective Action
Sensor is not dry	Dry sensor and try the zero cal again
Sensor wiring is incorrect	Check wiring. Make sure that the correct colors go to the correct terminals, and that the connections are tight. Make sure that you have not clamped on the insulation instead of the conductor.
Faulty sensor	Replace sensor
Controller is faulty; fails self test (see section 5.2)	Re-check self test with sensor disconnected. If it still fails, send controller back for repair. If it passes, sensor is faulty.

OVERRANGE ERROR

This error condition will stop conductivity control. It indicates that the conductivity signal from the sensor is no longer valid. This prevents controlling based upon an incorrect conductivity reading. This error will occur at 1.5 times the full scale range (i.e. on the 10,000 μ S scale, overrange error occurs at 15,000 μ S). The upper display line will show "OVER." The lower display line will show "overrange."

Possible Cause	Corrective Action
Sensor wire(s) disconnected	Reconnect.
Too low a range selected	Increase range (see Section 5.3)
Sensor coated with conductive substance	Clean sensor.
Faulty sensor	Replace sensor.
Faulty controller	Verify via failed self test.

High Alarm

This error message appears if the sensor reading exceeds the set point for one of the Control outputs that has been configured as a high alarm output. There are a number of possible causes for this condition:

Possible Cause	Corrective Action
The process went further out of control than normal.	May have to increase chemical flow rate.
The chemical supply has run out.	Replenish the chemical supply.
The pump or valve or supply line is faulty.	Repair or replace the control device.
Wrong chemical is being controlled.	Replace with correct chemical.
The sensor is not responding to changes.	Replace sensor, cable or preamplifier. Evaluate mixing or recirculation.
The pump is siphoning, valve leaking.	Repair or replace the control device or re-route tubing.
Control output has been left in "HAND" mode.	Switch back to "AUTO".
It may be a normal part of the process.	None required.

Probe Error

This error message appears if the sensor input signal is outside of the normal range of -2000 to 2000 mVDC. This usually indicates that the sensor has been disconnected or is faulty. It could appear under normal conditions if the conductivity is outside of the operating range of the sensor that is connected.

Possible Cause	Corrective Action
Controller is faulty; fails self test (see section 5.2)	Re-check self test with sensor disconnected. If it still fails, send controller back for repair. If it passes, sensor is faulty.
Sensor has no power to it.	Check +5V, -5V terminals vs IN- terminal. Should read +5VDC $\pm 5\%$ and -4.6 VDC $\pm 5\%$.
Sensor is faulty.	Indicated if ± 5 VDC power out of spec w/sensor attached, but in spec without sensor attached. Replace sensor.

Interlock

This error message indicates that control has been stopped because the closed contact signal from a flow switch or level switch is now open and one or more control outputs have been programmed to interlock.

Possible Cause	Corrective Action
Flow has stopped, level too low.	May be a normal condition, otherwise restore flow or level.
Flow, level switch disconnected.	Reconnect.
Flow, level switch faulty.	Verify that switch closes using an ohmmeter. If not, repair or replace.
Controller faulty.	Verify that error message disappears if controller flow switch input is shorted. If not, repair controller.

Calibration Time

This message appears to prompt you to perform the routine maintenance of cleaning and calibrating the sensor. It does not appear based upon any analysis of the condition of the sensor. The frequency of calibration is set by the user in the "Days Between Cal" menu found in the "Sensor" menu. If you do not want to be prompted to perform a calibration, set this menu to "0".

Low Alarm

As above for "High Alarm", except that the sensor reading is below the set point of one of the Control outputs that has been set up as a low alarm output. Refer to the possible causes and corrective actions listed above for the "High Alarm" error message.

Out Range Alarm

This error message appears if the sensor reading is outside of the range selected for one of the Control outputs that has been programmed as an "Out of Range Alarm". Refer to the possible causes and corrective actions listed above for the "High Alarm" error message.

In Range Output

This error message appears if the sensor reading is inside of the range selected for one of the Control outputs that has been programmed as an "In Range Alarm". Refer to the possible causes and corrective actions listed above for the "High Alarm" error message.

Temp Sensor Err

This error message appears if the signal from the automatic temperature compensation element disappears during operation. It is usually caused by a failure of the sensor, or by a problem with the cabling or connections of the cable.

Measure the resistance at each connection between the sensor and the controller to determine if the sensor, cabling or connections are faulty. A higher reading or open circuit (infinite resistance) may indicate a bad connection. A lower reading may indicate a shorted cable.

Temperature	Temperature Sensor Resistance
0° C	330 kΩ
25° C	100 kΩ
50° C	36 kΩ
100°C	6.8 kΩ

7.2 Interferences

The principle of operation involves a drive coil inducing a current in a receive coil. The liquid being tested is the coupling media. Calibration factors are determined when these coils are completely surrounded by this liquid. Should anything interfere with this coupling (i.e. buildup on the sensor, close proximity to the tank wall, any submerged object, like a tumbling barrel), the reading will be distorted.

If the interference is a conductive object, it will increase the reading. If the interference is a non-conductive object (which displaces the liquid), the reading will be reduced. Keep these principles in mind when placing the sensor as well as when troubleshooting.

Since the sensor is reading a current, it is important not to place the sensor in the path of any electrical currents in the solution (such as those commonly found in electroplating baths or electrocleaners), as this will shift the reading.

8.0 SERVICE POLICY

The WEC Series Electrodeless Conductivity Controller has a 2-year warranty on electronic components and a 1-year warranty on mechanical parts (keypad, terminal strip and relays).

We stock circuit boards for immediate exchange after we have isolated the cause of the problem.

Factory authorized repairs that are received by next-day-air will be returned within 24 hours. Normal priority for returns is two weeks.

Out of warranty repairs or circuit board exchanges are done on a flat fee basis after the warranty is expired.

Model Code

WEC410	-	Voltage	Output	Sensor	U (USB)	
WDEC410	-	Voltage	Output	Sensor1	Sensor2	U (USB)

VOLTAGE

- 1 120 VAC, prewired
- 5 Hardwired, cable glands

OUTPUT

- N No 4-20 mA output
- 4 Single isolated 4-20 mA output
- 2 Two isolated 4-20 mA outputs

SENSOR OPTIONS (20 FT. CABLES)

- N No sensor

0.1 – 1.0 mS/cm

- A Submersion PEEK sensor
- B In-line PEEK sensor w/stainless steel 2" NPTM adapter
- C Submersion CPVC sensor
- D In-line CPVC sensor w/ CPVC 2" NPTM adapter

1.0 – 10.0 mS/cm

- E Submersion PEEK sensor
- F In-line PEEK sensor w/stainless steel 2" NPTM adapter
- G Submersion CPVC sensor
- H In-line CPVC sensor w/ CPVC 2" NPTM adapter

10.0 – 100 mS/cm

- I Submersion PEEK sensor
- J In-line PEEK sensor w/stainless steel 2" NPTM adapter
- K Submersion CPVC sensor
- L In-line CPVC sensor w/ CPVC 2" NPTM adapter

100 – 1000 mS/cm

- M Submersion PEEK sensor
- O In-line PEEK sensor w/stainless steel 2" NPTM adapter
- P Submersion CPVC sensor
- Q In-line CPVC sensor w/ CPVC 2" NPTM adapter

USB FEATURES

- U Integrated datalogging, event/reset logging, and configuration file import/export

FIVE BOYNTON ROAD
TEL: 508-429-1110

HOPPING BROOK PARK
FAX: 508-429-7433

HOLLISTON, MA 01746 USA
Web: www.walchem.com