

W A L C H E M

IWAKI America Inc.

EHE Series Metering Pumps

EHE Series Electronic Metering Pump Instruction Manual

Notice

© 2023 WALCHEM, Iwaki America Inc. (hereinafter "Walchem")
Five Boynton Road, Holliston, MA 01746 USA
tel (508) 429-1110
All Rights Reserved
Printed in USA

Proprietary Material

The information and descriptions contained herein are the property of WALCHEM. Such information and descriptions may not be copied or reproduced by any means, or disseminated or distributed without the express prior written permission of WALCHEM.

This document is for information purposes only and is subject to change without notice.

Statement of Limited Warranty

WALCHEM warrants equipment of its manufacture and bearing its identification to be free from defects in workmanship and material for a period of two years from date of delivery from the factory or authorized distributor under normal use and service and otherwise when such equipment is used in accordance with instructions furnished by WALCHEM and for the purposes disclosed in writing at the time purchased, if any.

WALCHEM's liability under this warranty shall be limited to replacement or repair, F.O.B. Holliston, MA U.S.A. of any defective equipment or part which, having been returned to WALCHEM, transportation charges prepaid, has been inspected and determined by WALCHEM to be defective.

THIS WARRANTY IS IN LIEU OF ANY OTHER WARRANTY, EITHER EXPRESS OR IMPLIED, AS TO DESCRIPTION, QUALITY, MERCHANTABILITY, FITNESS FOR ANY PARTICULAR PURPOSE OR USE, OR ANY OTHER MATTER.

P/N E00022.Y
February 2023

TABLE OF CONTENTS

Thank you for choosing a Walchem E Series metering pump. This instruction manual deals with the correct installation, operation, programming maintenance, and troubleshooting procedures for the EHE Series metering pumps. Please read through it carefully to ensure the optimum performance, safety and service of your pump.

1.0	INTRODUCTION	1
1.1	Safety and Caution Notes	1
1.2	Principle of Operation.....	1
1.3	Specifications.....	2
1.4	Dimensions	3
2.0	INSTALLATION.....	5
2.1	Unpacking.....	5
2.2	Location	5
2.3	Supply Tubing	7
2.4	Discharge Tubing.....	8
2.5	Installing Injection Check Valve.....	8
2.6	Interlocking Pump	9
2.7	Electrical	9
3.0	OPERATION	10
3.1	Priming.....	10
3.2	Adjustment.....	10
3.3	Calibration.....	10
3.4	Control Unit Operation and Programming	11
3.5	Input Wiring and Connections	21
3.6	AC Power Interruption.....	22
4.0	MAINTENANCE	23
4.1	Diaphragm Replacement.....	23
4.2	Valve Replacement	23
4.3	Tubing.....	23
5.0	EXPLODED VIEW AND PARTS GUIDE	24
5.1	How to order parts for your metering pump.	24
5.2	Accessories (Not shown).....	24
5.3	EHE31, 36, 46 Liquid End Exploded View.....	25
5.4	EHE 56 Liquid End Exploded View.....	27
5.5	EHE 36-HV Liquid End Parts List	29
5.6	Drive Control Components	30
5.7	Assembly Part Numbers.....	30
5.8	Spare Parts Kit.....	31
6.0	TROUBLESHOOTING.....	32
7.0	SERVICE POLICY.....	32

1.0 INTRODUCTION

1.1 Safety and Caution Notes



Always wear protective clothing, eye protection and gloves before working on or near a metering pump. Follow all recommendations of the supplier of the solution being pumped. Refer to the MSDS from the solution supplier for additional precautions.

Walchem E Series metering pumps should NOT be installed where ambient temperatures exceed 122°F (50°C) or fall below 32°F (0°C). Pumps should always be shielded from direct exposure to the elements. Black UV resistant tubing should be used if the tubing is exposed to strong UV radiation (sunlight/lamps).



WARNING Risk of electrical shock! This pump is supplied with a grounding conductor and grounding-type attachment plug. To reduce the risk of electrical shock, be certain that it is connected only to a properly grounded, grounding type receptacle with ratings conforming to the data on the pump data plate. Prior to performing any maintenance on a pump, disconnect the pump from the electrical power source.



Plumbing Precautions

All tubing must be securely attached to the fittings prior to starting the pump (see Section 2.3). Only use Walchem tubing with your pump. Tubing should be shielded to prevent possible injury in case of rupture or damage. UV resistant tubing should be used if the tubing is exposed to UV light. Always adhere to local plumbing codes and requirements. Be sure that the installation does not constitute a cross connection. Walchem is not responsible for improper installations. Prior to performing any maintenance on a pump, depressurize the discharge tubing.

If you are pumping downhill or into little or no system pressure, a back pressure/anti-siphon device must be installed to prevent over-pumping. Contact your Walchem distributor for additional information.



Solution Compatibility

CAUTION! This pump has been evaluated for use with water only. The suitability of this pump for use with liquids other than water (such as acids or alkalis) is the responsibility of the user. For liquids other than water, select the best-suited liquid end material combination using a chemical compatibility chart or guidance from the solution supplier. NSF61 certification is only maintained when used with NSF60 certified chemicals. NSF/ANSI/CAN 61 addresses health effects only and does not address the disinfection efficacy of the product.

1.2 Principle of Operation

The E Series electronic metering pump consists of a pump unit, a drive unit, and a control unit. The drive unit is an electromagnetic solenoid. When the solenoid coil is energized by the control unit, the armature shaft moves forward due to the magnetic force of the solenoid. The shaft is attached to a PTFE faced diaphragm, which is part of the pump unit. The diaphragm is forced into the pump head cavity decreasing volume and increasing pressure which forces liquid in the pump head out through the discharge check valves. When the solenoid coil is de-energized, a spring returns the armature to its starting position. This action pulls the diaphragm out of the head cavity increasing volume and decreasing pressure. Atmospheric pressure then pushes liquid from the supply tank through the suction check valves to refill the pump head.

1.3 Specifications



1 Pump Series

EHE Electronic metering pump with external Analog and pulse control or manual speed control (adjustable to 360 strokes per minute). Manually adjustable stroke length. (Turndown ratio 1800:1)

2 Capacity/Pressure Rating

Size	Output Capacity				Output per stroke (mL)		Maximum Pressure		Conn. Size (in) Tubing O.D.
	(GPH)		(mL/min)		min	max	(PSI)	(MPa)	
	min	max	min	max					
E31	0.0031	5.5	0.189	340	0.189	0.94	150	1.0	½" O.D.
E36	0.0047	8.5	0.289	520	0.289	1.44	105	0.7	½" O.D.
E46	0.0067	12.0	0.417	750	0.417	2.08	60	0.4	½" O.D.
E56	0.0111	20.0	0.694	1250	0.694	3.47	30	0.2	½" O.D.
E36-HV	0.0047	5.2	0.274	329	0.274	1.37	73	0.5	½"OD (Dis) x ½" ID (Suc)
E46-HV	0.0067	8.0	0.417	499	0.417	2.08	60	0.4	½"OD (Dis) x ½" ID (Suc)

3 Control Module

E For use on all EHE models, features analog and external pulse control with pulse divide and multiply capability.

4 Voltage

- 1** 115VAC, 50/60 Hz
- 2** 230VAC, 50/60 Hz

5 Liquid End

Liquid End Code	Pump Head & Fittings	Diaphragm*	Valve Balls	Valve Seat	Valve Seals	Gasket	Tubing
HV	GFRPP	PTFE	SS/HC	PCTFE	FKM	PTFE	N/A
VC	PVC	PTFE	CE	FKM	FKM	PTFE	PE
VE	PVC	PTFE	CE	EPDM	EPDM	PTFE	PE
VF	PVC	PTFE	PTFE	EPDM	EPDM	PTFE	PE
PC	GFRPP	PTFE	CE	FKM	FKM	PTFE	PE
PE	GFRPP	PTFE	CE	EPDM	EPDM	PTFE	PE
FC	PVDF	PTFE	CE	PCTFE	PTFE	PTFE	PE
VM †	M-PVC	PTFE	CE	FKM	PTFE	PTFE	PE

† E56 Model only

* Bonded to EPDM

Materials of Construction

CE Alumina ceramic	PCTFE Polychlorotrifluoroethylene
EPDM Ethylene propylene diene monomer	PE Polyethylene
FKM Fluoroelastomer	PTFE Polytetrafluoroethylene
GFRPP Glass fiber reinforced polypropylene	PVC Polyvinylchloride (translucent)
M-PVC Machined polyvinylchloride	PVDF Polyvinylidene fluoride
HC Hastelloy C276 (spring in HV)	

6 Special Head Options

Blank = 1/2" O.D. tube connection and standard accessories. (HV is 1/2" O.D. discharge x 1/2" I.D. suction)

V = Standard 1/2" tube connections with back pressure/anti-syphon valve added. (Not available on FC models)

T = 3/4" NPT (male) pipe thread connection. (1/2" MNPT on HV pumps). No MAVV.

P = 3/4" NPT (male) connection (1/2" MNPT on HV pumps) with back pressure/anti-syphon valve. No MAVV.

NOTES: All pumps include a manual air vent valve with the exception of FC/HV liquid ends and pumps with options P and T. All pumps include one foot valve, one injection valve, 20 feet of polyethylene tubing and one ceramic weight with the exception of HV models (tubing only) and options P and T.

NPT piping connection material of construction will be the same as the liquid end.

Adjustment Range

Stroke length adjustment range
 Frequency adjustment range

20% to 100% Stroke Length
 1 to 360 strokes per minute (1 to 240 strokes per minutes for -HV)

Operating Conditions

Ambient temperature
 Relative humidity
 Liquid temperature

32 to 122°F (0 to 50°C)
 30 to 90% non-condensing
 32 to 104°F (0 to 40°C) for PVC based Liquid Ends
 32 to 140°F (0 to 60°C) for PP or PVDF based Liquid Ends

1.4 Dimensions
PVC & GFRPP Models

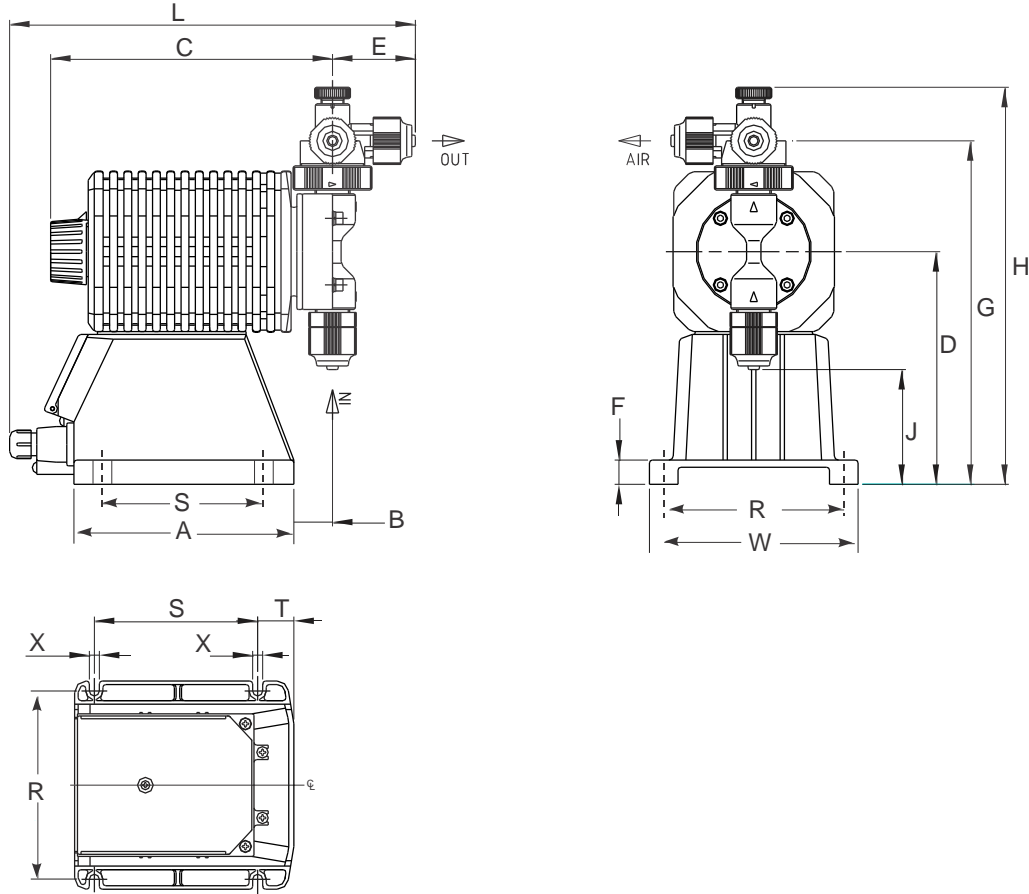

Model					A	B	C	D	E	F	G	H	J	L	W
EHE	31	E1	-VC	-PE	6.06	1.05	7.76	6.42	2.28	0.67	9.49	10.95	3.15	11.18	5.75
	36	E2	-PC	-VF											
EHE	46	E1	-VC	-PE	6.06	1.14	7.83	6.42	2.28	0.67	9.86	11.34	2.80	11.25	5.75
		E2	-PC	-VF											
EHE	56	E1	-VC	-PE	6.06	1.42	8.13	6.42	2.28	0.67	10.10	11.57	2.38	11.55	5.75
		E2	-PC	-VF											
EHE	56	E1	-VM		6.06	1.42	8.13	6.42	2.28	0.67	10.10	11.57	2.38	11.55	5.75

Mounting Dimensions	R	S	T	X
EHE all variations	5.20	4.50	1.00	0.28

FC and HV Models

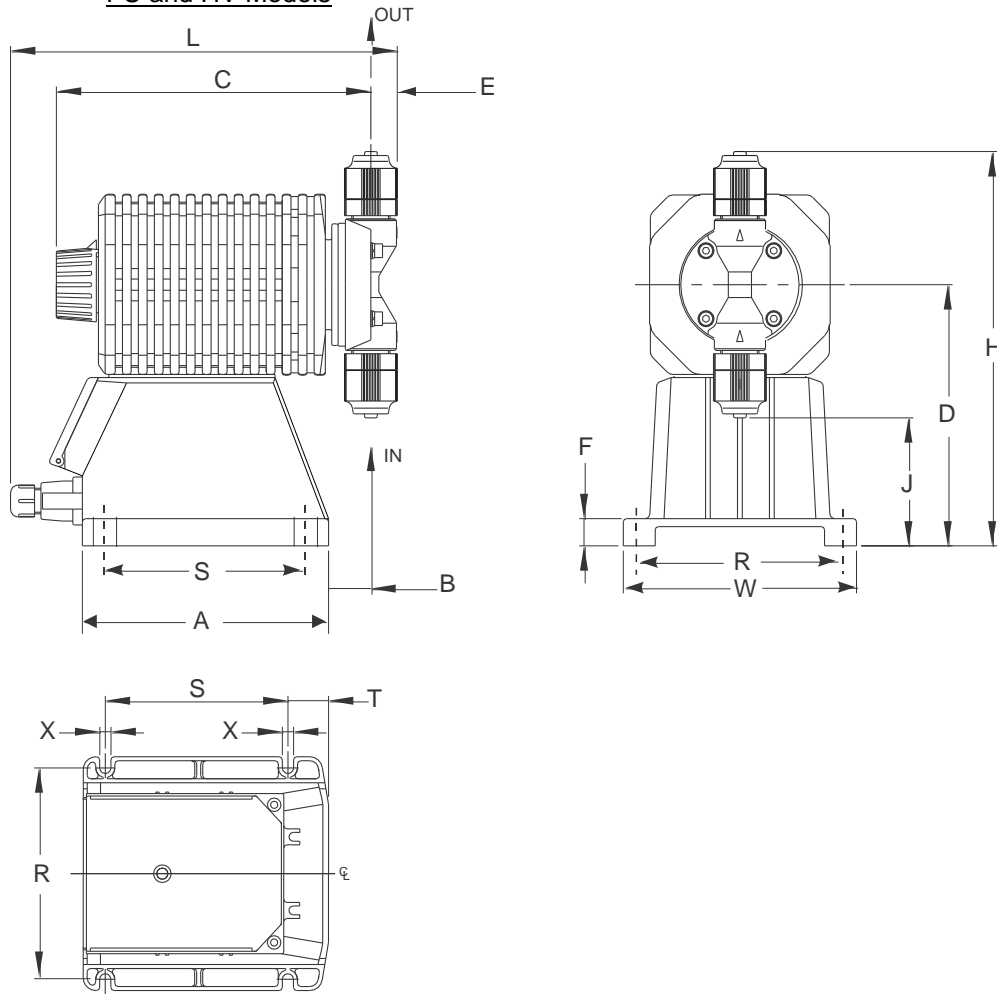

Model				A	B	C	D	E	F	H	J	L	W
EHE	31 36	E1 E2	-FC	6.06	1.05	7.76	6.42	0.65	0.67	9.69	3.15	9.53	5.75
EHE	46	E1 E2	-FC	6.06	1.14	7.83	6.42	0.75	0.67	10.00	2.80	9.72	5.75
EHE	56	E1 E2	-FC	6.06	1.42	8.13	6.42	0.85	0.67	10.45	2.38	10.12	5.75
EHE	36/46	E1 E2	-HV	6.06	1.05	7.80	6.42	0.70	0.67	9.69	2.95	9.60	5.75

Mounting Dimensions	R	S	T	X
EHE all variations	5.20	4.50	1.00	0.28

All dimensions in inches

2.0 INSTALLATION

2.1 Unpacking

Open the shipping carton and inspect contents for damage. If any items are missing or damaged contact your local distributor to arrange for replacement.



CAUTION

Pumps are pre-primed with water at the factory. If the application is not compatible with water, drain and dry before use. Be sure to remove caps from fittings before attaching tubing.

Head bolts may have loosened during storage or shipment. Be sure to check and tighten to 19 lb-in of torque, as necessary.

The electronics within the pump can be damaged by excessive surges in voltage. Do not install the pump near high-power electrical equipment that generates high surge voltages. Avoid branch circuits that also supply power to heavy or other equipment that could generate electrical interference. If necessary, install a surge suppression device (such as a varistor with a resistance greater than 2000A) or a noise-reducing transformer at the pump's power connection.



WARNING: Risk of electrical shock! *This pump is supplied with a grounding conductor and grounding-type attachment plug. To reduce the risk of electrical shock, be certain that it is connected only to a properly grounded, grounding type receptacle.*

2.2 Location

Choose a location for the pump that is clean, dry, vibration –free, close to an electrical outlet, and allows convenient access to stroke length control, frequency control, and tubing connections. Avoid areas where ambient temperature exceeds 122°F (50°C) or falls below 32°F (0°C). Pumps should always be shielded from direct exposure to the elements. Black UV resistant tubing should be used if the tubing is exposed to strong UV radiation (sunlight/lamps).

This pump is cord connected and not intended for permanent mounting to a building structure. However, temporary mounting to stabilize the pump during operation may be necessary as long as tools are not required for the installation or removal of the pump.

Flooded suction (mounting the pump below the level of liquid in the supply tank) is strongly recommended, especially when pumping liquids that readily generate gas bubbles. Sodium hypochlorite and hydrogen peroxide are common examples of such liquids. (See Figure 1.)

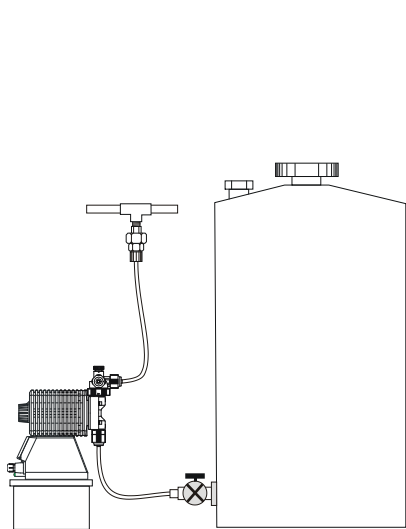

Figure 1
Flooded Suction

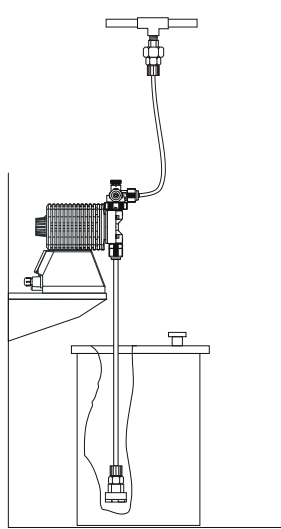

Figure 2
Shelf Mount
Suction Lift

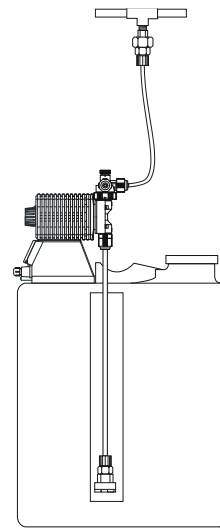

Figure 3
Tank Mount
Suction Lift

If flooded suction mounting is not possible, a shelf adjacent to (but not directly above) the supply tank often works well (see Figure 2). The supply tank or cover can also be used if it has provisions for mounting a pump (see Figure 3). In any case, the total suction lift should not exceed 5 ft (1.5m). For extremely gaseous liquids such as Sodium Hypochlorite or Hydrogen Peroxide, pulling from an external manifold will significantly reduce gas bubbles to the suction side of the pump. This installation will typically solve most priming issues associated with these gaseous liquids. See Figure 4 for reference.

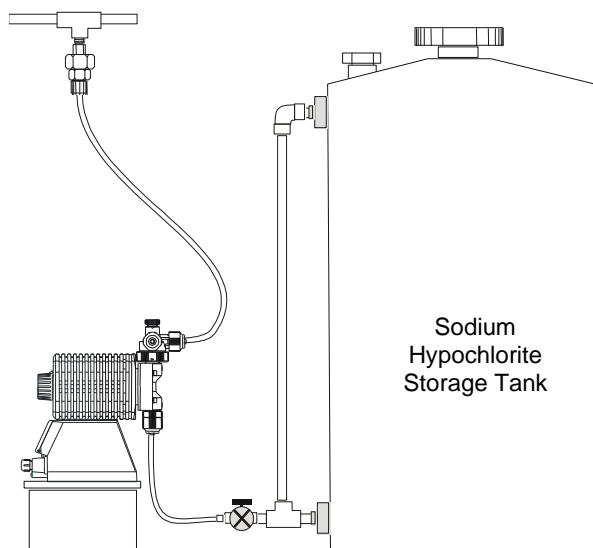

Figure 4
Flooded Suction for Gaseous Liquids

The EH-HV Series pumps require a flooded suction or pre-primed condition before operation. Flooded suction (mounting the pump below the level of liquid in the supply tank) is recommended for proper operation of high viscosity pumps. (See Figure 1) These pumps are not designed to be self-priming.

The pump is supplied with ½” tube or ½” NPT male suction and discharge connections depending on model. Mount the pump close to the supply tank and arrange the suction piping to be as short and straight as possible. Avoid piping installations where air may become trapped in the suction piping.

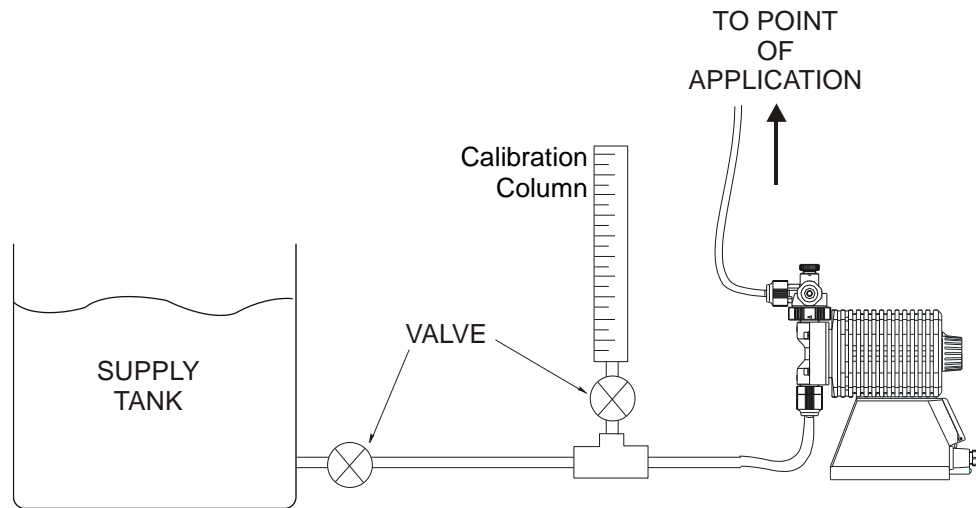
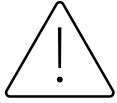

Figure 5

2.3 Supply Tubing

The supply tubing run should be as short as possible. For flooded suction mounting, install a shut-off valve with an appropriate tubing connector at the tank outlet. Cut a length of tubing from the coil supplied and install between the shut-off valve and the pump inlet fitting. For suction lift applications, install a foot valve on one end of suction tubing and cut the tubing to a length such that the foot valve hangs vertically about 1 in (25mm) above the bottom of the tank. Avoid any loops in the tubing run that could form a vapor trap. Running the tubing through a length of rigid pipe will help to keep tubing straight (see Figure 3). Total vertical suction lift should be no more than 5ft. (1.5m).

Attach tubing as shown in Figure 5. First slide the coupling nut, small end first, onto the tubing. Then slide on the clamp ring so that the rounded edges face the end of the tubing. Next push the tubing onto the tubing adapter fitting. (Tips: Place tubing adapter fitting on a flat surface such as a table top and press tubing down on top of it *all the way to the lip* of the tubing adapter fitting. If the tubing is stiff from cold, dip the tubing end in hot tap water for a few minutes so it will slide on and flare out more easily. Slide clamp ring down until it tightens over the adapter fitting. Then slide coupling nut down as far as it will go. Insert this arrangement into the suction valve housing. With one hand holding tubing and applying slight downward pressure, tighten the coupling nut until secure.



WARNING: All fittings and coupling nuts should be tightened by hand. If necessary, small pliers may be used to make it snug. **DO NOT** use excessive force or large wrenches.

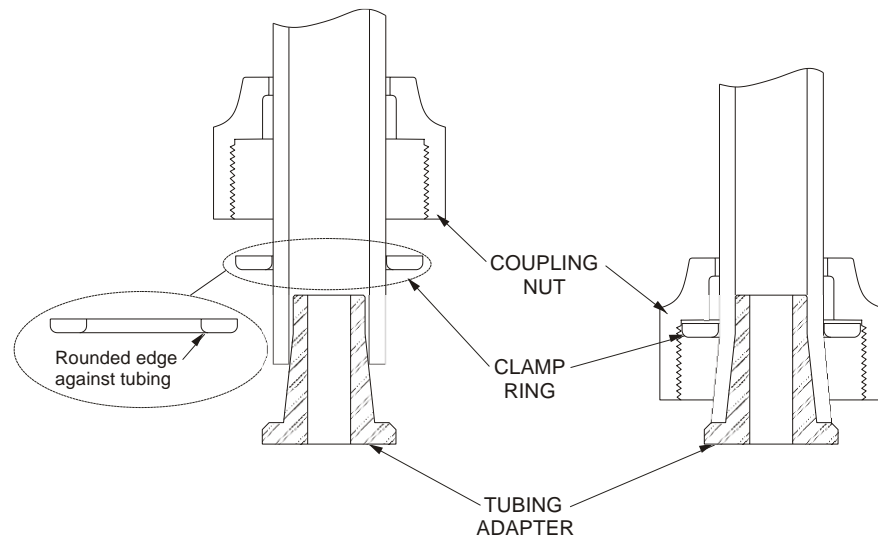

Figure 6 Tubing Connections

2.4 Discharge Tubing

Cut a length of tubing long enough to go from the pump to the application (injection) point. Additional tubing can be ordered from your distributor. Avoid sharp bends or kinks in the tubing and protect the tubing from sharp edges that could chafe or cut it. If applicable, install the injection valve in 1/2" NPT thread at the injection point and connect the discharge tubing to the injection valve. Attach the tubing as described above in Section 2.3, Figure 5.

Note: Most pump models have an air vent valve with two connections on the discharge side of the pump head. The connection marked 'OUT' is the discharge connection plumbed to the injection point. The connection marked 'AIR' is the vent connection and tubing should be routed from this point back to the chemical solution (supply) tank or drum. Refer to Section 1.4 drawing.

2.5 Installing Injection Check Valve

A fitting or tee with 1/2" NPTF threads and sufficient depth should be used to install the injection valve assembly. If required, trim off an amount of the extension tip until it fits your fitting or tee (see Figure 7). Attach the supplied tubing to the compression end: cut the tubing square, slide on the coupling nut, push the tubing to the bottom of the cone (use warm water to soften tubing as necessary), and hand tighten coupling nut.

The position of the injection check valve can be at any orientation as long as the spring is retained in the valve. **DO NOT REMOVE THE SPRING.** Be sure to check/replace the spring as needed.



CAUTION: Some chemicals may have reactions as they are injected into the main flow (ie. sulfuric acid may react with water causing excess heat). If that chemical is heavier than water, mount the injection valve as close as possible to vertical, injecting into the bottom of the pipe. This will keep the injection nozzle facing up and keep the heavier chemistry from draining into the pipe causing adverse reactions within the injection valve and pipe.

In addition to preventing backflow from pressurized lines, the injection valve will provide a limited amount of backpressure when pumping into open atmosphere type applications. However, the backpressure by the injection check valve is very low and can vary. Metering pump output is rated at

maximum backpressure and, depending upon the application, may be higher if the back-pressure is lower than rated. Additionally, the valve does NOT act as an anti-siphon valve. If siphoning is a possibility, or if pumping downhill into open atmosphere (open tank), a separate backpressure/anti-siphon valve must be installed.

NOTE: Siphoning can also occur at the tip of the injection valve because of the high flow rate in the main pipe flowing past the small injection nozzle (venturi effect). In this case, an anti-siphon device must be installed to avoid over feeding or siphoning of chemistry into the line. Cutting the injector tip at an angle or to a different length will sometimes alleviate this problem.

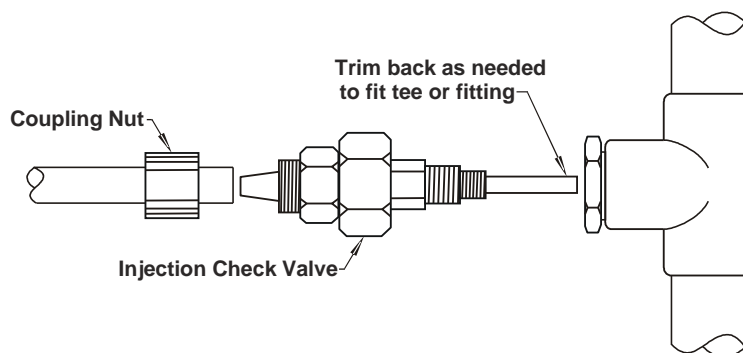

Figure 7
Injection Check Valve Installation

2.6 Interlocking Pump



CAUTION! Control of pump operation is critical. Operation and chemical addition during no flow situations can create hazardous situations from elevated chemical concentrations and chemical gasses trapped in the line.

Ensure that during no flow conditions such as when the well pump, main line or recirculation pump is off, and for pools/spas, in times of backwash, that the metering pump is not allowed to operate. If using a controller (pH/ORP/pool) for automated control and flow indication is tied into it, pump operation can be interlocked to the controller.

Interlocking the pump operation can also be done directly using a flow switch located in the water, main or pool/spa recirculation lines. The flow switch can be tied directly into the pumps to stop operation during no flow conditions.

2.7 Electrical



WARNING Risk of electrical shock! This pump is supplied with a grounding conductor and grounding-type attachment plug. To reduce the risk of electrical shock, be certain that it is connected only to a properly grounded, grounding type receptacle.



CAUTION! The electronics within the pump can be damaged by excessive surges in voltage. Do not install the pump near high-power electrical equipment that generate high surge voltages. Avoid branch circuits that also supply power to heavy or other equipment that could generate electrical interference. If necessary, install a surge suppression device (such as a varistor with a resistance greater than 2000A) or a noise reducing transformer at the pump's power connection.

3.0 OPERATION

3.1 Priming

Install the pump as described in Section 2.0. With the pump plugged in but not pumping, set stroke length at 100% and frequency at 360 (use the ▲ or ▼ buttons as necessary to adjust the frequency). If the pump is equipped with a manual air vent valve, open the knob ½-1 turn; otherwise disconnect the discharge tubing from the injection valve. Push the **START/STOP** button to start the pump. As *soon as* liquid enters the discharge tubing at the pump head, push the **START/STOP** button again to stop the pump. Close the air vent valve and/or reconnect the discharge tubing to the injection valve.

If the pump does not self-prime, remove the check valve housing on the discharge and suction sides to make sure the valve cartridges and gaskets are in correct positions (see Section 4.2). Remove and shake cartridges to make sure ball is loose inside. Wetting cartridges before re-installing will help in priming.

3.2 Adjustment

The pump will operate best with the stroke length at 100%. If less than full output is required, set the frequency to the desired percentage of maximum.

Example: Model EHE31E1-VC has maximum output of 5.5 GPH at 360spm and 100%SL.

Desired output is 4.0 GPH.

$4.0 \div 5.5 = 0.73$ or 73%. 73% of 360spm is 263spm.

Press the ▲ or ▼ buttons as necessary to set the frequency to 263spm.

If very low outputs are required, it will be necessary to also reduce the stroke length. (Minimum recommended stroke length is 20%.)

3.3 Calibration

If the application requires the pump to be calibrated, prime and adjust the pump per directions above. Then connect a calibration column to the suction side of the pump and re-prime the pump to eliminate any air.

Turn the pump on for one minute and read the amount of liquid pumped from the column.

Adjust the frequency up or down as necessary and check the output again. When the desired output is reached, disconnect the calibration column and reconnect the suction tubing. (See Figure 8.)

End user is responsible for following local regulations for the monitoring frequency of the pump output. Adjustment of the pump and recalibration may be needed.

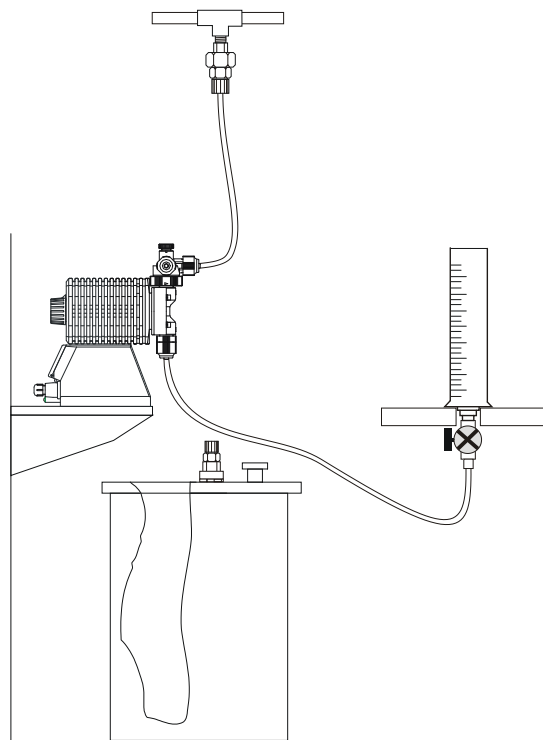
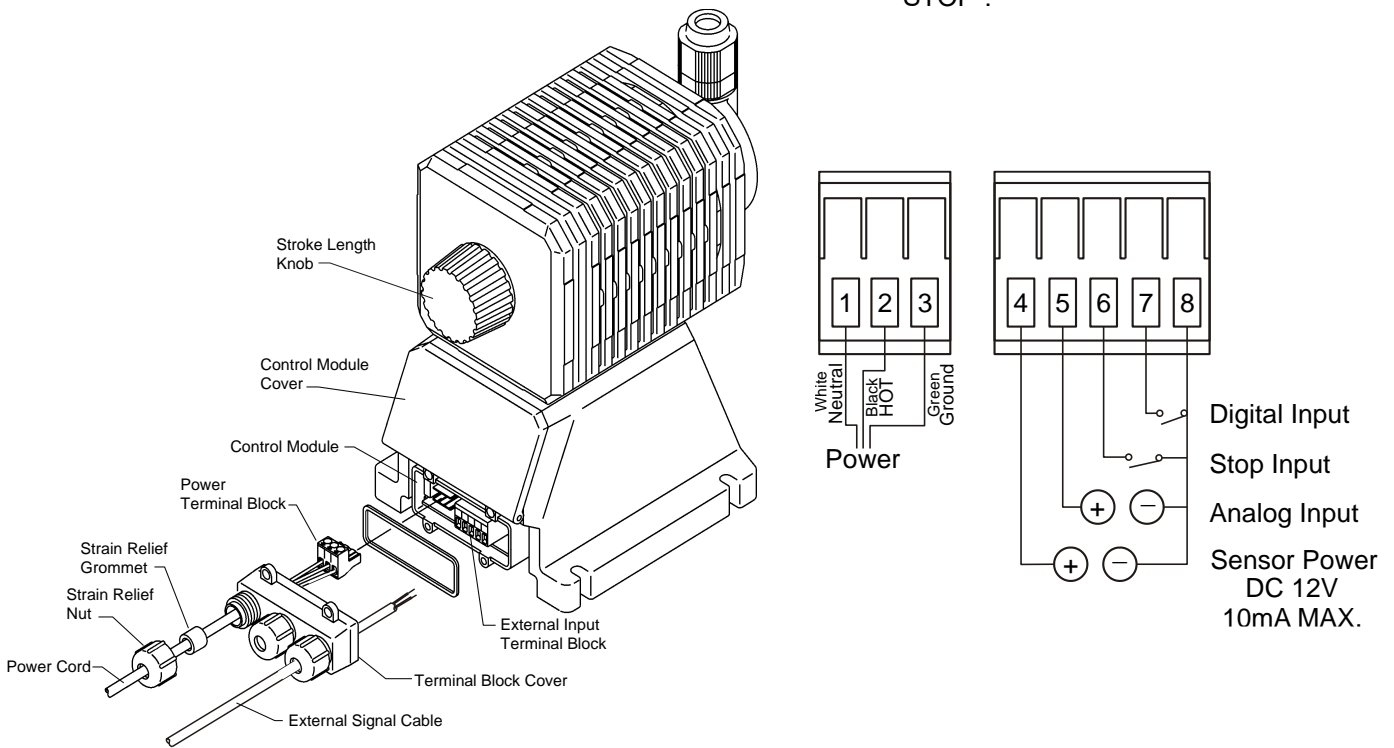
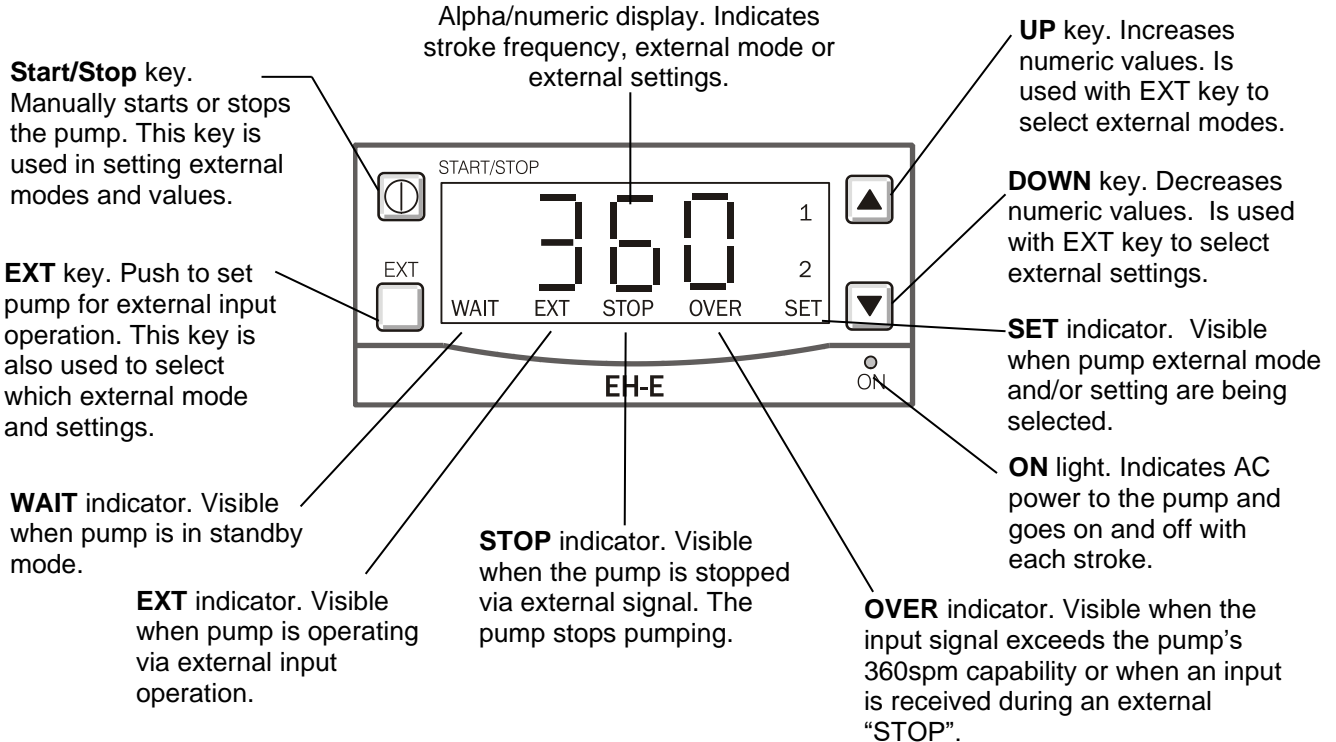

Figure 8
Pump Calibration

3.4 Control Unit Operation and Programming

The EHE Series metering pumps can be operated in either manual or external modes. The external mode can be controlled from a digital or analog external signal. An external stop function is available for remotely suspending operation of the pump and functions independent of the control mode.

Display/Keypad Overview



EH-E Program Overview

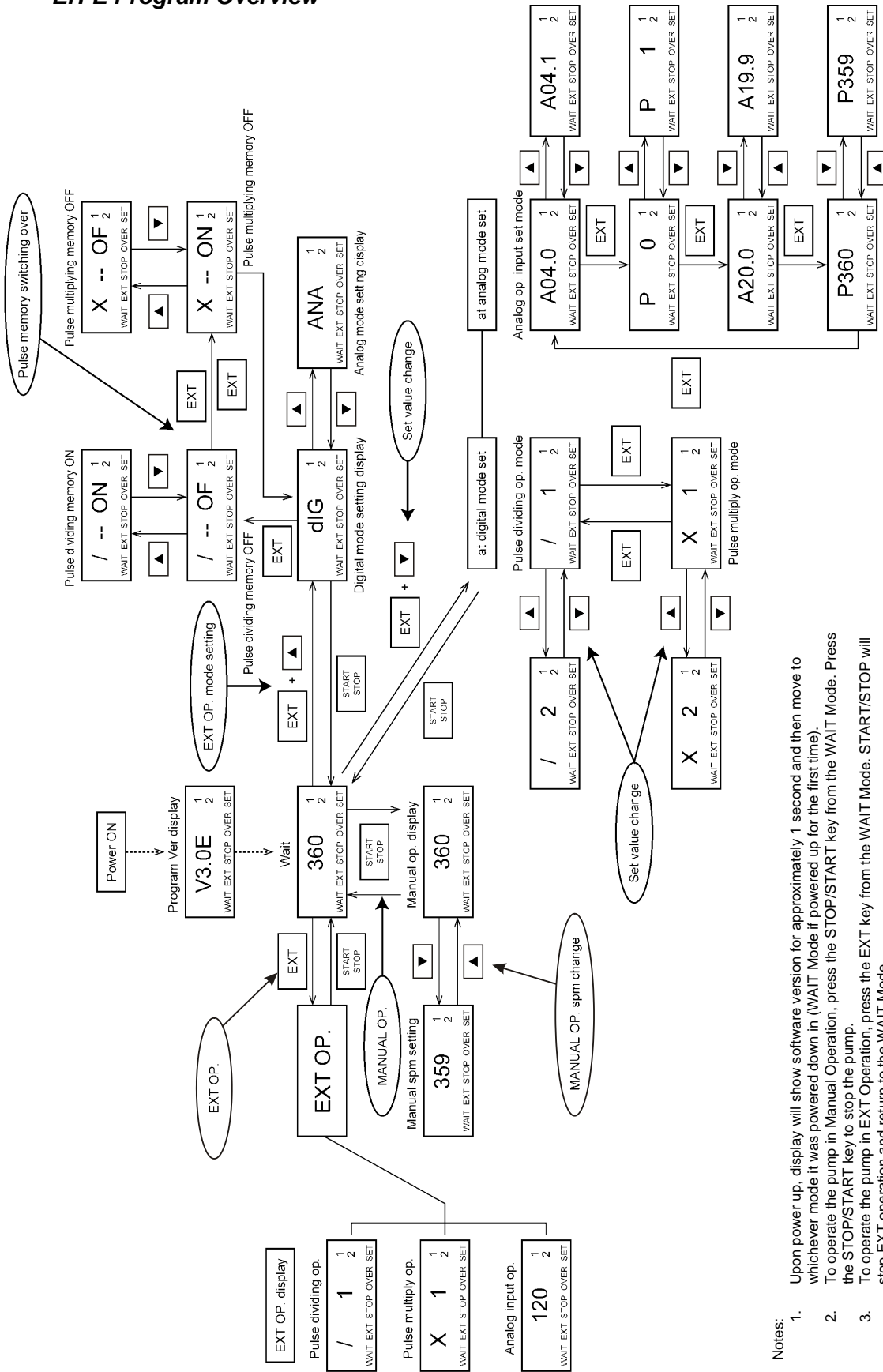

Notes:

1. Upon power up, display will show software version for approximately 1 second and then move to whichever mode it was powered down in (WAIT Mode if powered up for the first time).
2. To operate the pump in Manual Operation, press the STOP/START key from the WAIT Mode. Press the STOP/START key to stop the pump.
3. To operate the pump in EXT Operation, press the EXT key from the WAIT Mode. START/STOP will stop EXT operation and return to the WAIT Mode.
4. To change input operation between Digital or Analog, press the EXT and ▲ keys simultaneously. Toggle between DIG or ANA with the ▲ or ▼ keys and select the desired control method by pressing with the STOP/START key. This will also exit this menu.
5. Input Pulse Memory can be turned on/off in the DIG mode. While selecting DIG in step 4, pressing the EXT key will move to this selection. On/Off is toggled with the ▲ or ▼ keys and the EXT key will switch between multiply and divide. Press the STOP/START key to return to the WAIT Mode.
6. To set the input operation values, press the EXT and ▼ keys simultaneously from the WAIT Mode. The values are changed with the ▲ or ▼ keys. The EXT key is used to toggle between MULT or DIV if set in DIG mode and will scroll through the (4) setpoints in ANA mode.

Manual Operation

(1) Power ON

When power is applied to the pump, the green indicator above ON lights up, the display momentarily shows the software version (“Vx.xE”), and the controller goes to whatever mode the pump was in when power was disconnected. If being powered for the first time, the stroke rate is then displayed, the “WAIT” is lit, and pump is then in the Wait Mode.

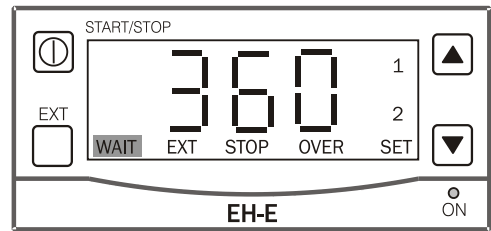

(2) The stroke rate (spm) can be changed by pressing the ▲ or ▼ keys in either the Wait Mode or during operation. Press the ▲ to increase the stroke rate and the ▼ key to decrease the rate. Holding the keys down briefly will change the rate slowly, but holding them down for 3 seconds will change the rate rapidly. The default setting shipped from the factory is 360 spm.

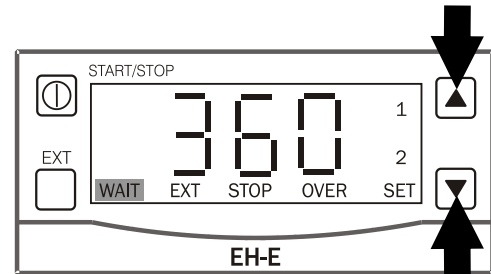

(3) Pressing the STOP/START key will start pump operation. The WAIT backlight disappears and the green ON indicator blinks off with every stroke.

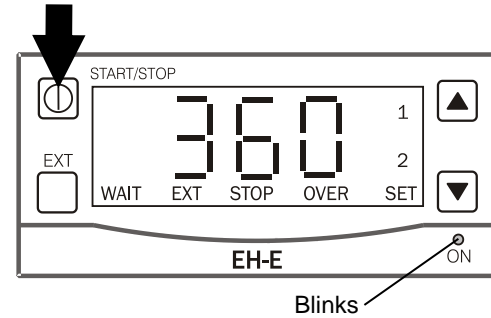

(4) Pressing the STOP/START key again will stop pump operation and the WAIT will be backlit as the pump enters the WAIT Mode.

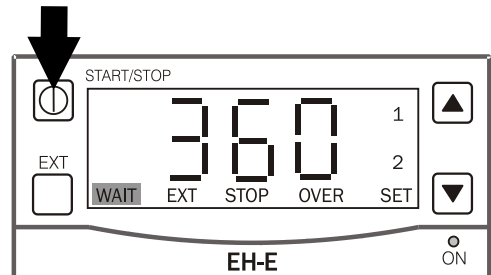

External Operation

ANALOG INPUT OPERATION

In analog mode the pump will accept a milliamp signal and produce a pump speed proportional to the signal level received. The input resistance of the analog signal is 250Ω. The pump's response can be fine-tuned by variable set points to meet system requirements.

(1) Power ON

When power is applied to the pump, the green indicator above ON lights up, the display momentarily shows the software version ("Vx.xE"), and the controller goes to whatever mode the pump was in when power was disconnected. If being powered for the first time, the stroke rate is then displayed, the "WAIT" is lit, and pump is then in the Wait Mode.

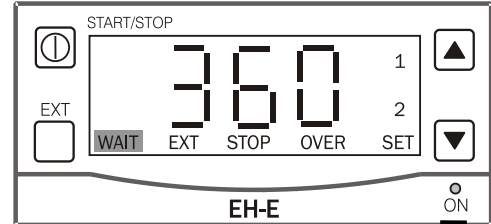

(2) Selecting the mode of EXT operation:

Press the EXT and the ▲ keys simultaneously. The WAIT backlight disappears, the SET backlight is lit, and the display shows "dIG" (if "ANA" is displayed, skip to step 3).

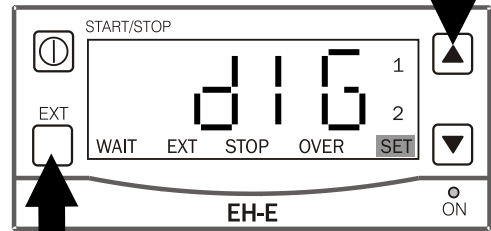

Change the mode by pressing the ▼ key. Every time the ▼ key is pressed, it toggles between the ANA and dIG modes. (Pump is shipped from the factory preset in the dIG mode)

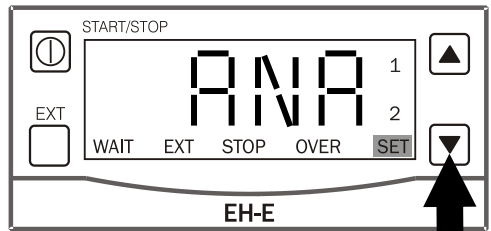

(3) Press the START/STOP key to confirm the Analog selection and return to the WAIT mode.

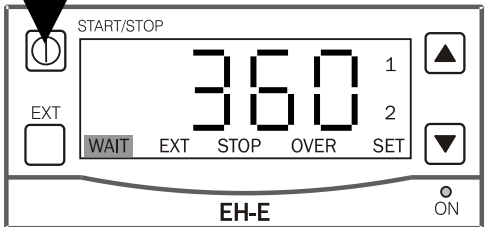

(4) Setting the Analog Input Set points:

(NOTE: Pump is pre-set at factory with the Analog set points set at 4.0mA = 0 SPM and 20.0mA = 360 SPM. If these are the desired set points, skip steps 4-12 and move to step 13.)

Press the EXT and ▼ keys simultaneously. The display will show the initial set point (default is A04.0) and the SET and 1 backlight will appear.

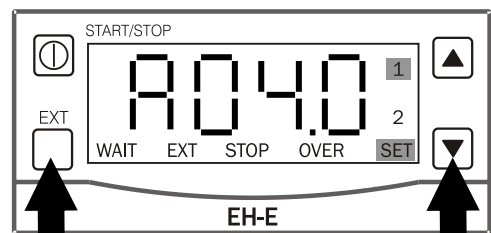

- (5) Setting the Input Current (mA) of SET point 1:
Use the ▲ and ▼ keys to set the input current (mA) of SET point 1. The value will increase with the ▲ key and decrease with ▼ the key. The numerical value will change slowly by 0.1mA if the keys are pressed briefly, but will increment rapidly if they are held for more than 3 seconds.
The allowable range is 0.0-20.0mA and the default setting from the factory is 4.0mA.

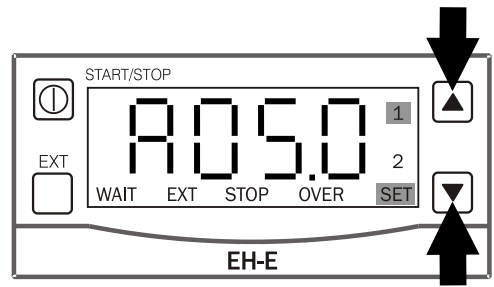

- (6) Press the EXT key to confirm the current value of SET point 1 and move to the pump speed (SPM) setting of SET point 1. "P 0" will be the default setting (Pump speed=0spm) and the SET and 1 will remain backlit.

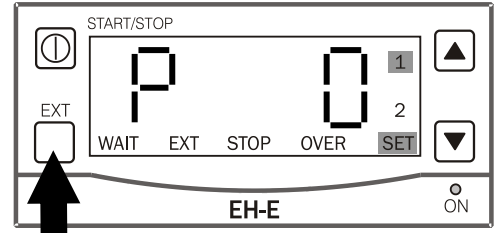

- (7) Setting the Stroke Rate of SET point 1:
Set the stroke rate corresponding to the current setting of SET point 1 using the ▲ and ▼ keys.
The allowable range is 0-360 spm and the default setting from the factory is 0 spm.

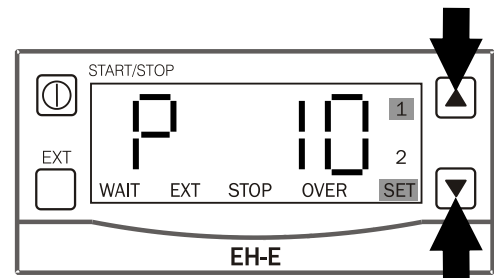

- (8) Press the EXT key to confirm the pump speed value of SET point 1 and move to the Current Input setting of Set point 2. The backlight behind SET will remain, but the light behind 1 will go off and 2 will become backlit. The default display will show A20.0.

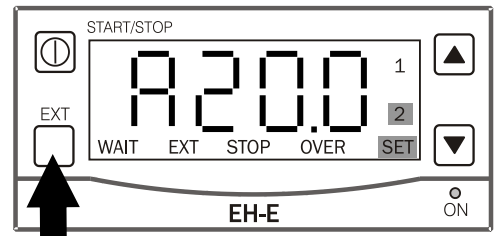

- (9) Setting the Input Current (mA) of SET point 2:
Use the ▲ and ▼ keys to set the input current (mA) of SET point 2. Do NOT set the value equal to SET point 1 or an error (ERR1) will occur.
The allowable range is 0.0-20.0mA and the default setting from the factory is 20.0mA.

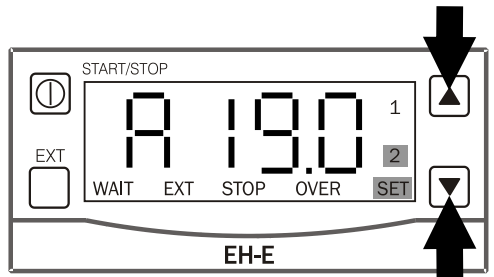

- (10) Press the EXT key to confirm the current value of SET point 2 and move to the pump speed (SPM) setting of SET point 2. "P360" will be the default setting (Pump speed=360spm) and the SET and 2 will remain backlit.

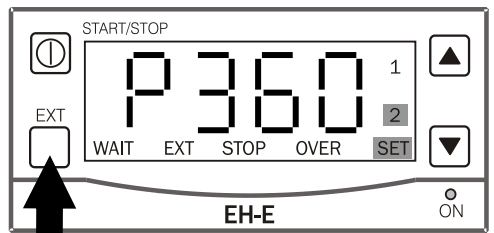

- (11) Setting the Stroke Rate of SET point 2:
 Set the stroke rate corresponding to the current setting of SET point 2 using the ▲ and ▼ keys.
 The allowable range is 0-360 spm and the default setting from the factory is 360 spm.

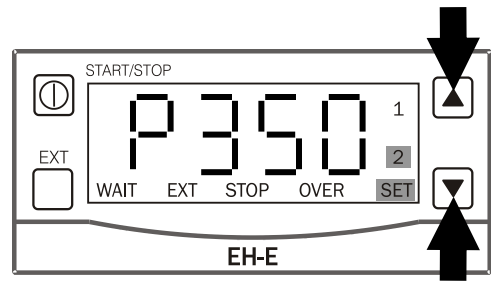

- (12) Press the STOP/START key to confirm the pump speed value of SET point 2 and move back to the WAIT mode. (Pressing the EXT key will move back to setting the current value of SET point 1 – step #4. Press the STOP/START key anytime to exit and go to the WAIT mode)

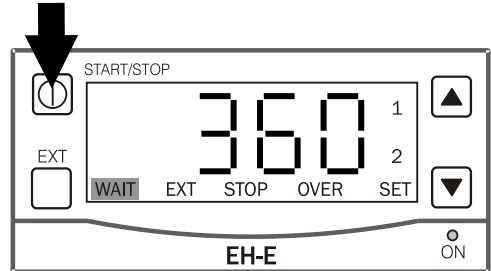

- (13) Press the EXT button to start EXT pump operation. The WAIT backlight will go out, EXT will become backlit, and the ON lamp will begin to blink with every stroke. The pump will operate at the speed corresponding to the incoming current (mA) signal.
 To stop the pump, press the STOP/START key once and the pump will enter the WAIT mode.
 Pressing the EXT again will restart the pump in EXT mode. (see wiring section to ensure the analog wiring is correct)

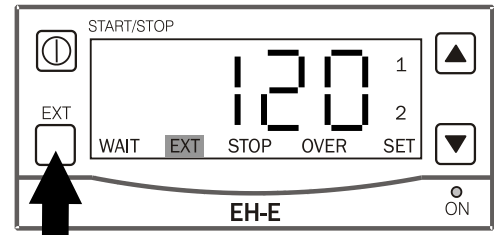

The pump speed will now be determined by the level of the milliamp signal as shown in the graph. The stroke length can be adjusted manually to set the volume pumped per stroke.

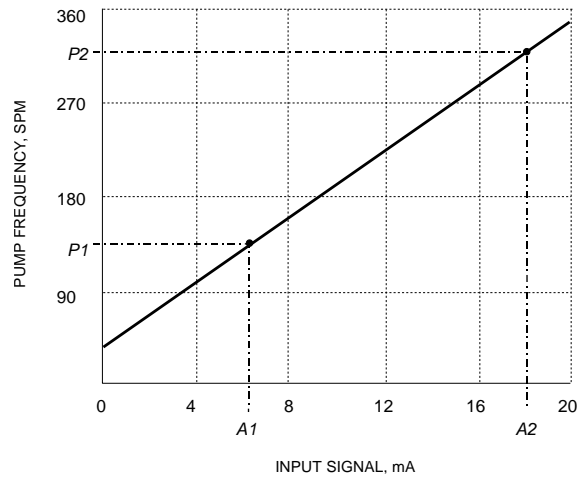

DIGITAL INPUT OPERATION

In digital mode, the pump can accept a non-powered (dry contact) pulse signal from a flowmeter or other similar instrument. The pump can be set to divide pulses by a factor of 1 to 999; or in multiply mode, 1 input pulse can produce 1 to 999 pump strokes. The minimum pulse width for input pulses is 10 mSec.

(1) Power ON

When power is applied to the pump, the green indicator above ON lights up, the display momentarily shows the software version (“Vx.xE”), and the controller goes to whatever mode the pump was in when power was disconnected. If being powered for the first time, the stroke rate is then displayed, the “WAIT” is lit, and pump is then in the Wait Mode.

(2) Selecting the mode of EXT operation:

Press the EXT and the ▲ keys simultaneously. The WAIT backlight disappears, the SET backlight is lit, and the display shows “dIG” or “ANA” (if “dIG” is displayed, skip to step 3). Change the mode by pressing the ▼ key. Every time the ▼ key is pressed, it toggles between the ANA and dIG modes. (Pump is shipped from the factory preset in the dIG mode)

(3) Move to the Pulse Input Memory menu:

Press EXT while dIG is displayed and “/--OF” or “/--ON” will be displayed. “/--OF” is the default set at the factory as it is rarely needed or used.

Pulse Input Memory: As digital pulses come into the pump – whether the pump will operate faster than the pulses (MULT) or at a fraction of the speed (DIV) – internal memory can be set to store these pulses if they come in too fast for the pump to keep up. Once the incoming pulses slow or stop, the pump will work off the excess pulses. The factory default settings are that the memory is OFF for the divide mode and ON for the multiply mode. A max. of 255 pulses can be stored.

NOTE! In the Multiply mode, stored pulses can cause the pump to run excessively after incoming pulses (usually indicating flow) have stopped. This could cause injection into a stagnant pipe.

(4) Use the ▲ and ▼ keys to toggle the divide memory ON and OFF. These will change the display between “/--OF” and “/--ON”.

(5) Pressing the EXT key moves to the memory setting for the MULT mode. “X--ON” is the default setting. Pressing the ▲ and ▼ keys will toggle the display between “X--ON” and “X--OF”.

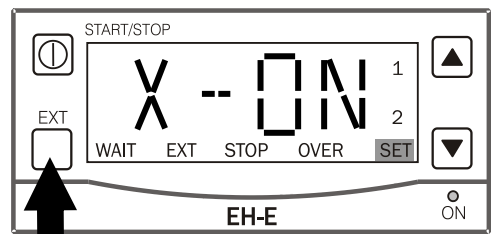
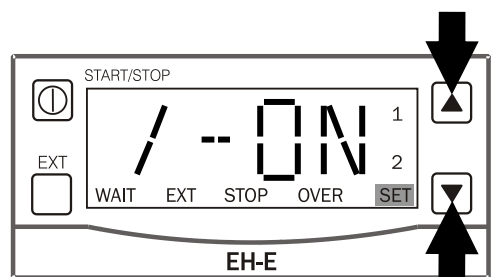
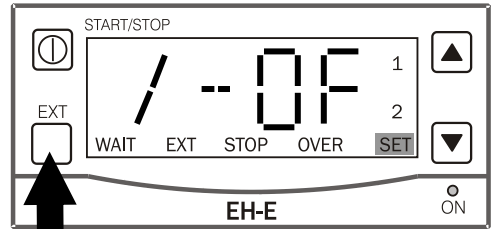
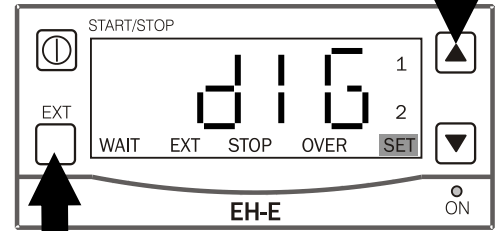
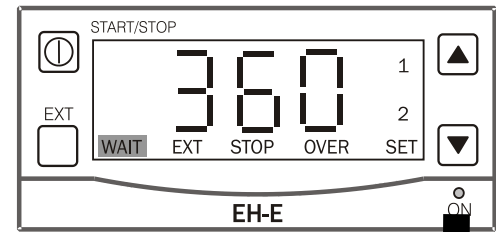

- (6) Press the EXT key to enter the memory selections and return to the “dIG” set menu.

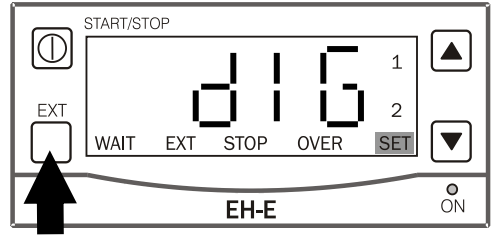

- (7) Press the START/STOP key to confirm the Digital Operation selection and return to the WAIT mode. The SET backlight will go out and the WAIT light will illuminate.

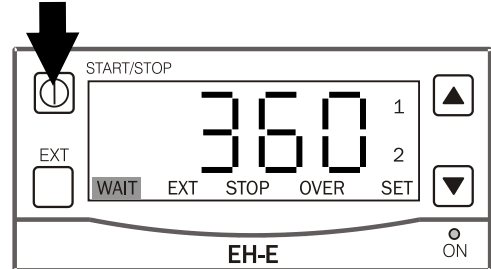

- (8) Digital Input Selection:
(NOTE: Pump is pre-set at factory with both MULT or DIV set to 1. The default Digital mode is preset to DIV.)
 Press the EXT and ▼ keys simultaneously. The display will show “/ 1” (Dividing mode) and the SET backlight will appear.

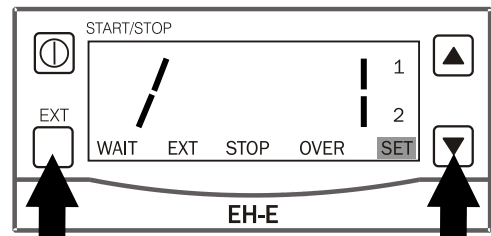

- (9) Pressing the EXT key toggles the mode of operation between “/” (DIV) and “X” (MULT).

Once the desired mode of operation is displayed (“X 1” for MULT or “/ 1” for DIV), set the value needed to be multiplied or divided.

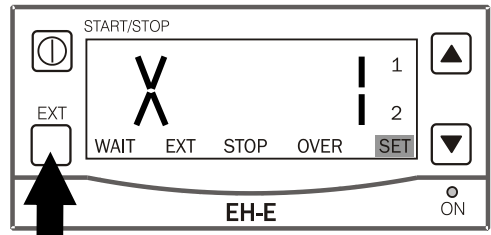

- (10) Setting the Stroke Rate:
 Set the desired multiplier or divider value using the ▲ and ▼ keys.
 The allowable range is 1-999 and the default setting from the factory is 1.

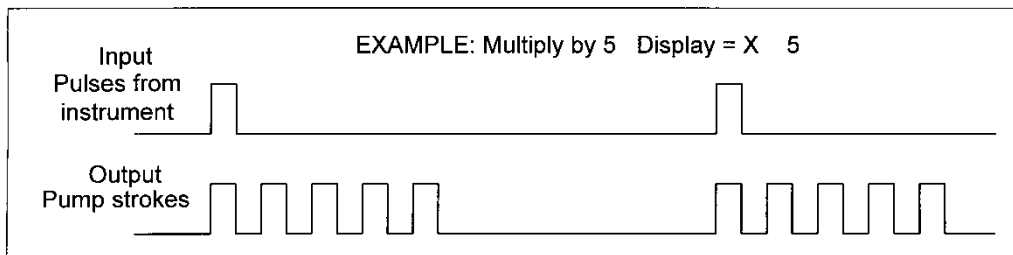
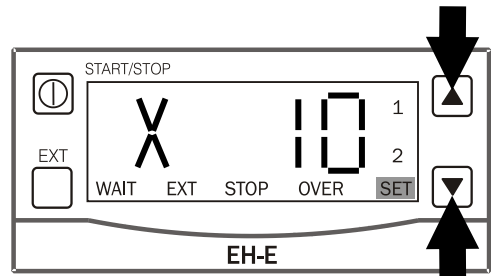

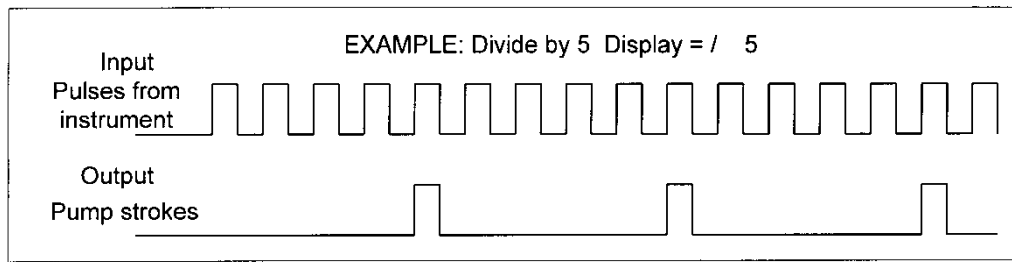

- (11) Press the START/STOP key to confirm the operation mode and value settings. This will also return to the WAIT mode. The WAIT light will illuminate and the backlight behind SET will go out.

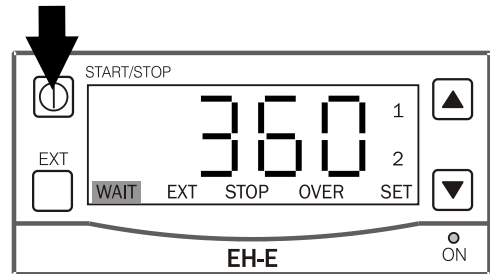

- (12) **IMPORTANT:** Changing the pump speed in the WAIT (or MAN) mode using the ▲ and ▼ keys sets the MAX operating speed the pump will operate in the Digital mode (MULT). This can be used to help moderate the pump output and reduce slug feeding. For example, if the pump is set to multiply by 10 and a max of 3 input pulses/min are expected from a flowmeter, instead of having the pump stroke 10 times in 2 seconds for each input pulse (pump set at 360SPM), the speed can be reduced to 40 SPM and the pump will take 15 seconds to evenly pump in the 10 strokes – the pump will be operating 45 seconds out of 60 instead of 6 out of 60.

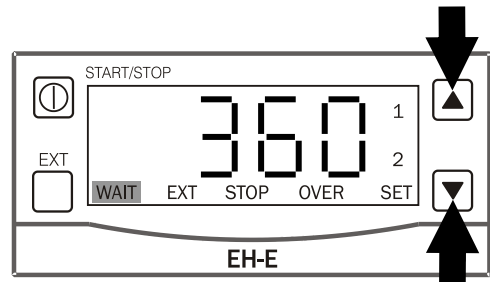

- (13) Press the EXT button to start EXT pump operation. The WAIT backlight will go out, EXT will become backlit, and the ON lamp will blink with every stroke. The pump will operate at the speed corresponding to the MULT or DIV setting of the incoming pulses. To stop the pump, press the STOP/START key once and the pump will enter the WAIT mode. Pressing the EXT again will restart the pump in EXT mode. (see wiring section to ensure the digital input wiring is correct)

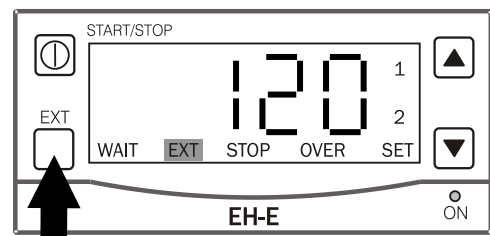

ALARM Indications

- (1) In ANALOG Input Operation, if the incoming current matching 360SPM (typically, 20mA=360SPM) is exceeded, the OVER will become backlit. The pump will continue to operate at 360SPM during this condition.

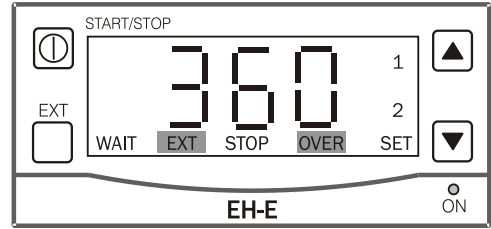

- (2) While programming the Analog Input Setpoints, if the same value (current or SPM) is set for both Setpoint 1 and 2, "ERR 1" will be displayed for 3 seconds. It will return to the programming menu so the setpoints can be corrected.

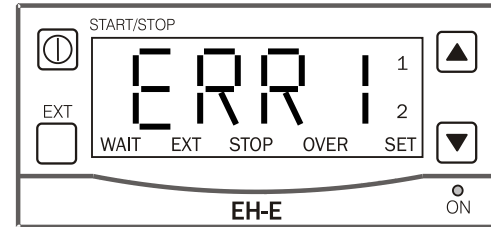

- (3) In DIGITAL Input Operation (Multiply or Divide modes), if the incoming pulses come in either during operation or exceed the pump doing 360SPM, the OVER will be come backlit. If the Pulse Input Memory is on, the pump will store the extra pulses (max. of 255 incoming pulses) and work them off as it can to catch up.

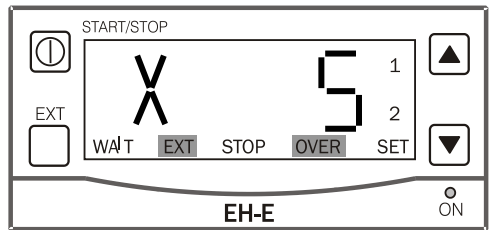

3.5 Input Wiring and Connections

Digital Mode

Connecting a digital input device

Disconnect AC power to the pump. Remove the four screws from the terminal block cover and remove the cover. Remove the cord nut and bushing from the terminal block cover. Remove the terminal block from the connector. Slide the nut and bushing over the external control cable and insert the cable through the terminal block cover. Strip 1/4" insulation from conductors and connect the positive side to terminal 7 and the negative side to terminal 8. (See Figure 8 and the schematic, below.)

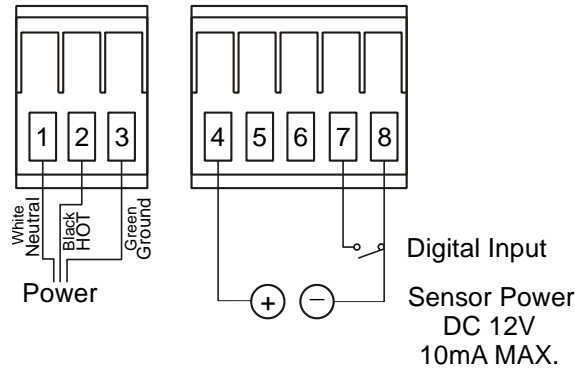

Connecting a digital input to multiple pumps in parallel

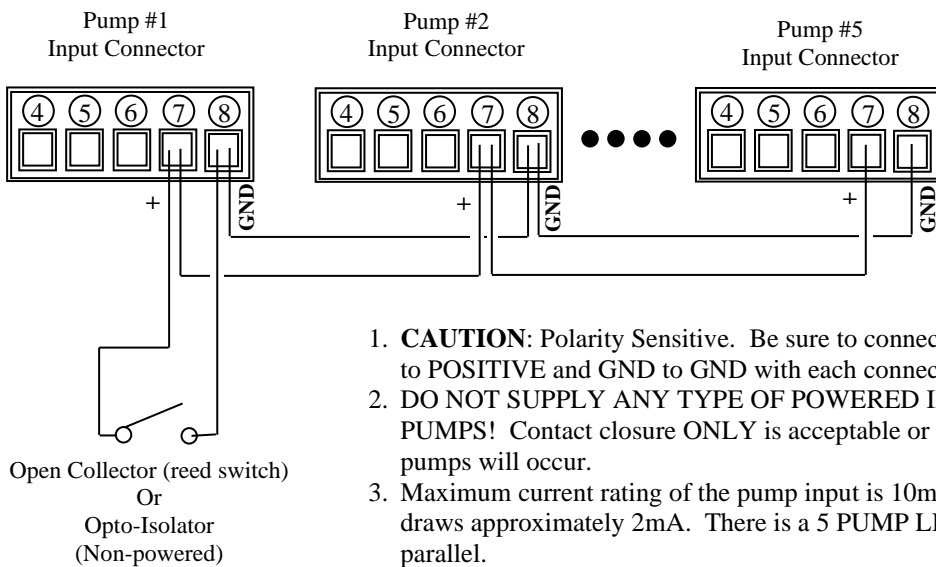

1. **CAUTION:** Polarity Sensitive. Be sure to connect the POSITIVE to POSITIVE and GND to GND with each connection.
2. DO NOT SUPPLY ANY TYPE OF POWERED INPUT TO THE PUMPS! Contact closure ONLY is acceptable or damage to the pumps will occur.
3. Maximum current rating of the pump input is 10mA. Each pump draws approximately 2mA. There is a 5 PUMP LIMIT of pumps in parallel.
4. Make sure the switching device can handle the maximum current in the system.

$$\text{Current} = 2\text{mA} \times \# \text{ of Pumps}$$

Sensor Power

The control circuit of the EHE series has the ability to provide 12 VDC at up to 10 mA to power a Hall effect sensor or similar device. Connect the sensor power leads to terminal 4 (positive) and terminal 8 (negative) of the terminal block.

Analog Mode

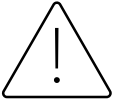

CAUTION: Open loop signal voltage must not exceed 25 VDC. If the signal voltage is greater than 25 VDC, power down the signal source prior to connection.

Connecting an analog signal device

Disconnect AC power to the pump. Remove the four screws from the terminal block cover and remove the cover. Remove the cord nut and bushing from the terminal block cover. Remove the terminal block from the connector. Slide the nut and bushing over the external control cable and insert the cable through the terminal block cover. Strip 1/4" insulation from conductors and connect the positive side to terminal 5 and the negative side to terminal 8. (See Figure 8 and the schematic to the right.)

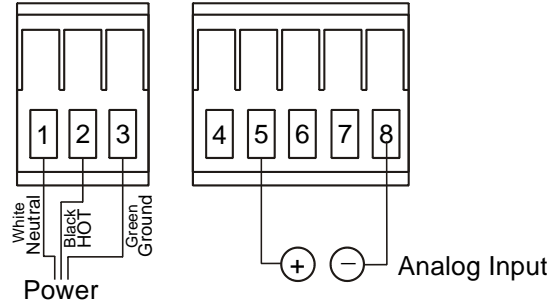

STOP Function

The EHE series pump also includes a **STOP** function that allows an external signal to stop the operation of the pump.

A switch or solid-state device capable of switching 5 VDC at 2 mA can be connected to terminals 6 (positive) and 8 (negative) of the terminal block. Closing this circuit temporarily interrupts pump operation. Opening this circuit resumes pump operation. If the pump is operating in external digital mode, any pulses received while the pump is stopped will be saved (up to a maximum of 255). When pump operation resumes, saved pulses will allow the pump to “catch up” by producing the correct number of pump strokes that should have occurred while it was stopped. The 'Over' indicator will light up if the pump receives pulses while in the 'Stopped' condition (see Figure 8 and the schematic below).

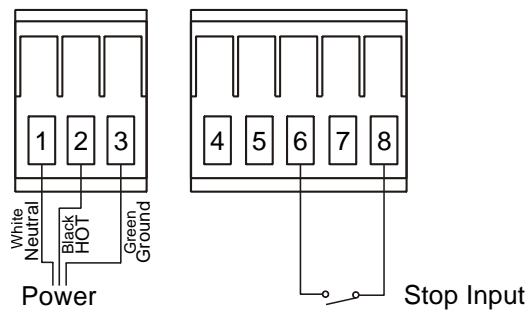

3.6 AC Power Interruption

If AC power is interrupted, the pump will power up as shown below:

State preceding power OFF	State following power ON
WAIT	WAIT
Run Manual	Run manual
Run external	Run external
Set EXTERNAL mode	WAIT
Set EXTERNAL values	WAIT

4.0 MAINTENANCE



CAUTION: Before working on the pump, disconnect the power cord, depressurize the discharge tubing and drain or flush any residual liquid from the pump head and valves. Always wear protective gear when working around chemicals.

4.1 Diaphragm Replacement

Disconnect AC power to the pump and disconnect the suction tubing and discharge tubing. Remove the four head bolts with a 4mm hex wrench. Turn the stroke length knob fully counter-clockwise. Unscrew the diaphragm and remove its retainer (small disk behind the diaphragm). **CAUTION:** *There may be small brass spacers between the retainer and the armature shaft. These spacers need to be re-used when replacing the diaphragm.* Install the new retainer and diaphragm on the shaft. Turn the diaphragm clockwise until it bottoms on the shaft. Use Caution when handling the diaphragm – the PTFE surface can be damaged by tools, nails, or any sharp objects. Replace the pump head and tighten the head bolts to a torque of 19 lb-in (2.16 N-m).

4.2 Valve Replacement

Making sure the discharge side has been depressurized, remove the suction and discharge tubing. Remove the suction fitting, two valve cartridges*, o-ring and gasket(s). Install the new o-ring, gasket(s) and valve cartridges. Be sure both valve seats are in the same orientation. Refer to Figure 9 below. Tighten the suction fitting. Similarly remove and replace the discharge valve cartridges, o-ring and gasket(s).

*EHE36-HV, EHE46 and EHE56 series have one valve cartridge on the suction and discharge sides. Refer to Section 5.0 for exploded view drawing and parts list.

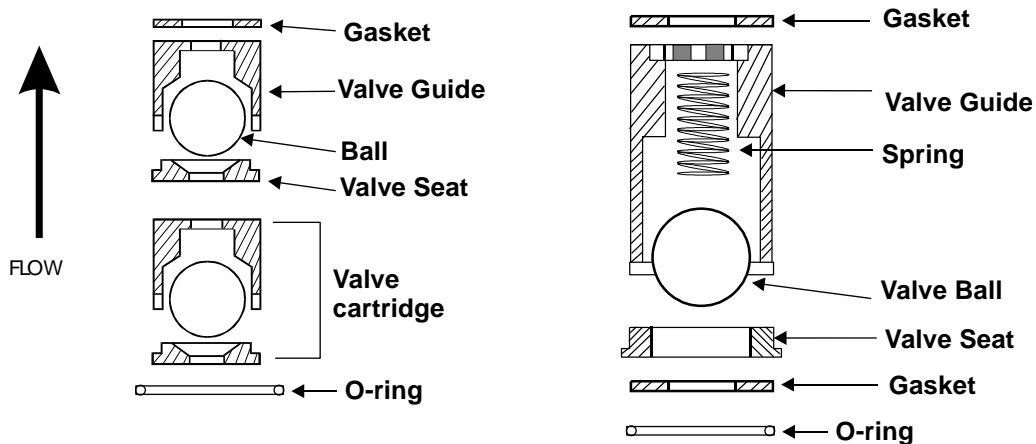

Figure 10 Valve Cartridge Orientation

4.3 Tubing

Check ends of tubing for splits, cracks or thin spots. Examine the full length of tubing for damage due to chafing, abrasion, stress cracks, excessive temperature or exposure to ultraviolet light (direct sunlight or mercury vapor lamps). If any signs of deterioration exist, replace the entire length of tubing. It is a good idea to replace discharge tubing on a regular preventative maintenance schedule every 12 months.

5.0 EXPLODED VIEW AND PARTS GUIDE

5.1 How to order parts for your metering pump.

Have your catalog or model number ready. This is found on the silver label on the side of the pump.

From the exploded view drawing, identify the item number of the part(s) to be ordered.

The item numbers are listed and include part number, description and size/material information.

Contact your Walchem distributor for further assistance.

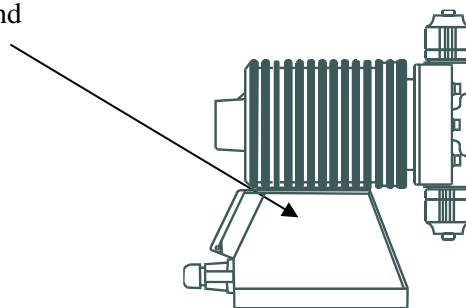

5.2 Accessories (Not shown)

Part No.	Description	Size	Liquid End Mtl
CAN-2PC-8	Valve, Injection, 1/2" PC HI-PR, Flexcon	31, 36, 46	PC
CAN-2PCL-8	Valve, Injection, 1/2" PC LO-PR, Flexcon	56	PC
CAN-2PE-8	Valve, Injection, 1/2" PE HI-PR, Flexcon	31, 36, 46	PE
CAN-2PEL-8	Valve, Injection, 1/2" PE LO-PR, Flexcon	56	PE
CAN-2VC-8	Valve, Injection, 1/2" VC HI-PR, Flexcon	31, 36, 46	VC
CAN-2VCL-8	Valve, Injection, 1/2" VC LO-PR, Flexcon	56	VC, VM
CAN-2VE-8	Valve, Injection, 1/2" VE HI-PR, Flexcon	31, 36, 46	VE, VF
CAN-2VEL-8	Valve, Injection, 1/2" VE LO-PR, Flexcon	56	VE, VF
E90022	Valve, Injection/Back Pressure, 1/2"	31, 36, 46, 56	FC
E90068	Valve, Fixed Back Pressure/Anti-Siphon, 1/2"	31, 36, 46, 56	VC, VE, VM, VF
E90069	Valve, Fixed Back Pressure/Anti-Siphon, 1/2"	31, 36, 46, 56	PC, PE
FSPCN-8U	Valve, Foot, 1/2" Flexcon	31, 36, 46, 56	PC
FSPEN-8U	Valve, Foot, 1/2" Flexcon	31, 36, 46, 56	PE
FSVCN-8U	Valve, Foot, 1/2" Flexcon	31, 36, 45, 56	VC
FSVEN-8U	Valve, Foot, 1/2" Flexcon	31, 36, 46, 56	VE
FSVFN-8U	Valve, Foot, 1/2" Flexcon	31, 36, 46, 56	VF
FSFCN-8U	Valve, Foot, 1/2" Flexcon	31, 36, 46, 56	FC
E00001	Tubing, 1/2" OD LLDPE, 20 FT	31, 36, 46, 56	All
E00001-50	Tubing, 1/2" OD LLDPE, 50 FT	31, 36, 46, 56	All
E00001-100	Tubing, 1/2" OD LLDPE, 100 FT	31, 36, 46, 56	All
E00001-500	Tubing, 1/2" OD LLDPE, 500 FT	31, 36, 46, 56	All
E00074-20	Tubing, 1/2" OD, UV Resistant, 20 FT	31, 36, 46, 56	All
E00074-50	Tubing, 1/2" OD, UV Resistant, 50 FT	31, 36, 46, 56	All
E00074-100	Tubing, 1/2" OD, UV Resistant, 100 FT	31, 36, 46, 56	All
E00074-500	Tubing, 1/2" OD, UV Resistant 500 FT	31, 36, 46, 56	All
E00071	Weight, Ceramic	31, 36, 46, 56	All
*E00030	Fitting (NPT Valve Housing) 1/2" NPT, PVC	31, 36	VC, VE, VF
*EH1244	Fitting (NPT Valve Housing) 1/2" NPT, PVC	46 (36)	VC, VE, VF, (HV)
*E00031	Fitting (NPT Valve Housing) 1/2" NPT, PP	31, 36	PC, PE
*E00032	Fitting (NPT Valve Housing) 1/2" NPT, PVDF	31, 36	FC
*E00033	Fitting (NPT Valve Housing) 3/4" NPT, PVC	31, 36	VC, VE, VF
*E00034	Fitting (NPT Valve Housing) 3/4" NPT, PP	31, 36	PC, PE
*E00035	Fitting (NPT Valve Housing) 3/4" NPT, PVDF	31, 36	FC
*E00036	Fitting (NPT Valve Housing) 3/4" NPT, PVC	46	VC, VE, VF, HV
*E00037	Fitting (NPT Valve Housing) 3/4" NPT, PP	46	PC, PE, HV
*E00038	Fitting (NPT Valve Housing) 3/4" NPT, PVDF	46	FC
*E00039	Fitting (NPT Valve Housing) 3/4" NPT, PVC	56	VC, VE, VM, VF
*E00040	Fitting (NPT Valve Housing) 3/4" NPT, PP	56	PC, PE
*E00041	Fitting (NPT Valve Housing) 3/4" NPT, PVDF	56	FC

* Fittings replace the Valve Housing (Item 3) and the complete Manual Air Vent Valve assembly (Item E) shown in exploded view.

5.3 EHE31, 36, 46 Liquid End Exploded View

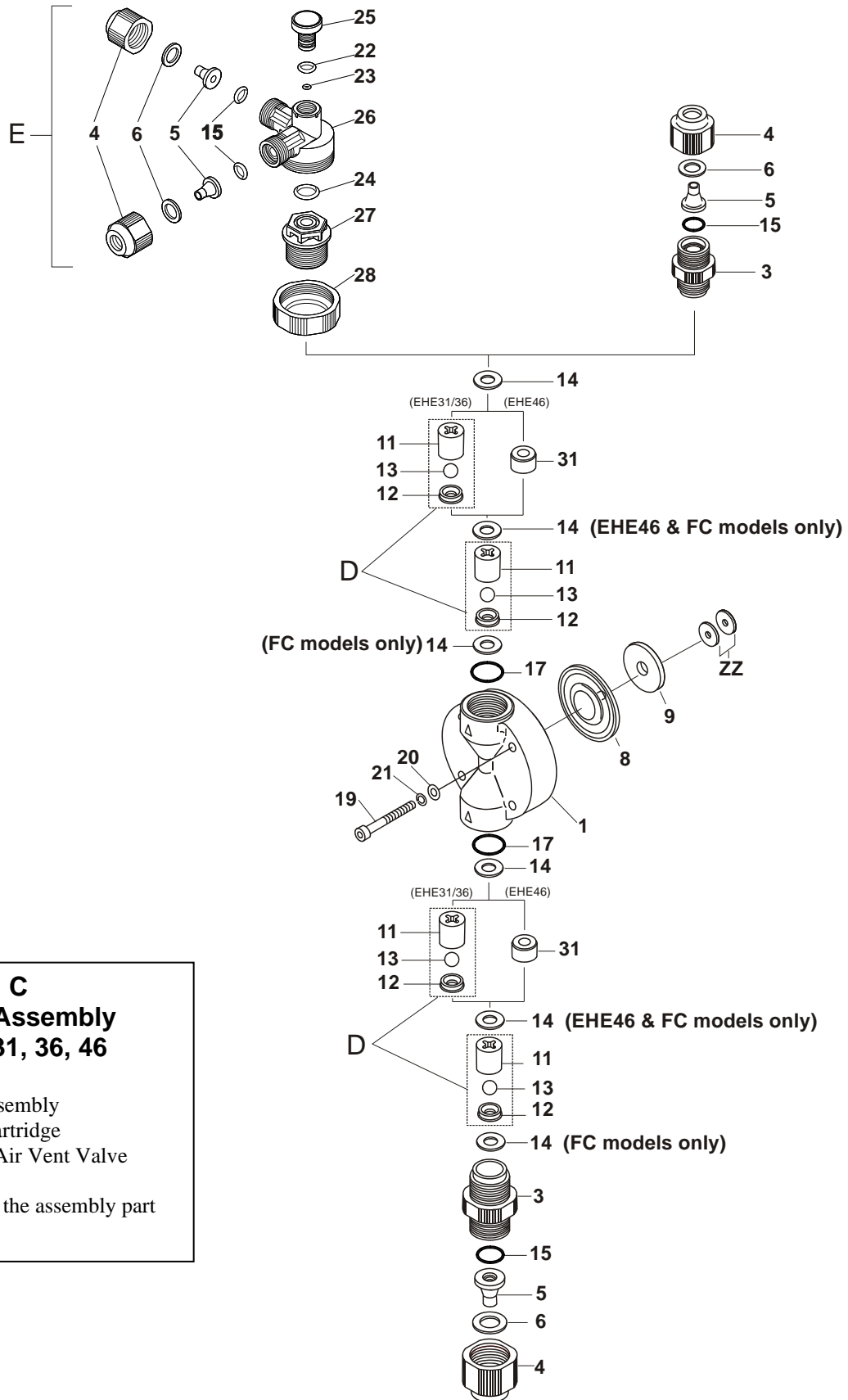

EHE31, 36, 46 Liquid End Parts List

Item	Part No	Description	Qty	Size	Liquid End Mtl
1	EH2101	Head, E31 PVC	1	31	VC, VE, VF
	EH2102	Head, E31 GFRPP	1	31	PC, PE
	EH2103	Head, E31 PVDF	1	31	FC
	EH1953	Head, E36 PVC	1	36	VC, VE, VF
	EH1962	Head, E36 GFRPP	1	36	PC, PE
	EH1967	Head, E36 PVDF	1	36	FC
	EH2109	Head, E46 PVC	1	46	VC, VE, VF
	EH2110	Head, E46 GFRPP	1	46	PC, PE
	EH2111	Head, E46 PVDF	1	46	FC
3	EH0619	Housing, Valve, ½PVC	1	31,36	VC, VE, VF
	EH0675	Housing, Valve, ½GFRPP	1	31,36	PC, PE
	EH0947	Housing, Valve, ½PVDF	2	31,36	FC
	EH0640	Housing, Valve, ½PVC	1	46	VC, VE, VF
	EH0679	Housing, Valve, ½GFRPP	1	46	PC, PE
	EH0932	Housing, Valve, ½PVDF	2	46	FC
4	EH0620	Nut, Coupling, ½PVC	3	31,36,46	VC, VE, VF
	EH0676	Nut, Coupling, ½GFRPP	3	31,36,46	PC, PE
	EH0933	Nut, Coupling, ½PVDF	2	31,36,46	FC
5	EH0719	Adapter, ½, PVC	3	31,36,46	VC, VE, VF
	EH0734	Adapter, ½ GFRPP	3	31,36,46	PC, PE
	EH0938	Adapter, ½ PVDF	2	31,36,46	FC
6	EH0720	Clamp Ring, 1/2 SS	3(2)	31,36,46	All (FC)
*8	EH2105	Diaphragm, PTFE/EPDM	1	31	All
	EH2108	Diaphragm, PTFE/EPDM	1	36	All
	EH2113	Diaphragm, PTFE/EPDM	1	46	All
*9	EH0622	Retainer, Diaphragm	1	31	All
	EH0637	Retainer, Diaphragm	1	36	All
	EH0642	Retainer, Diaphragm	1	46	All
*11	EH0118	Guide, Valve 0.375 PVC	4	31,36	VC, VE, VF
	EH0332	Guide, Valve 0.375 GFRPP	4	31,36	PC, PE
	EH0362	Guide, Valve 0.375 PVDF	4	31,36	FC
	EH0643	Guide, Valve 0.500 PVC	2	46	VC, VE, VF
	EH0680	Guide, Valve 0.500 GFRPP	2	46	PC, PE
	EH0934	Guide, Valve 0.500 PVDF	2	46	FC
*12	EH0119	Seat, Valve 0.375 FKM	4	31, 36	VC, PC
	EH0623	Seat, Valve, 0.375 EPDM	4	31, 36	VE, PE, VF
	EH0593	Seat, Valve, 0.375 PCTFE	4	31, 36	FC
	EH2241	Seat, Valve, 0.500 FKM	2	46	VC, PC
	EH0645	Seat, Valve, 0.500 EPDM	2	46	VE, PE, VF
	EH0935	Seat, Valve, 0.500 PCTFE	2	46	FC
*13	EH0120	Ball, Valve, 0.375 CE	4	31, 36	VC, VE, PC, PE, FC
	E00062	Ball, Valve, 0.375, PTFE	4	31, 36	VF

Item	Part No	Description	Qty	Size	Liquid End Mtl
*13	EH0646	Ball, Valve, 0.500, CE	2	46	VC, VE, PC, PE, FC
	E00072	Ball, Valve, 0.500, PTFE	2	46	VF
*14	EH0121	Gasket, Valve, 0.375 PTFE	2	31, 36	VC, VE, PC, PE, VF
	EH0364	Gasket, Valve, 0.375 PTFE	6	31, 36	FC
	EH0648	Gasket, Valve, 0.500, PTFE	4	46	VC, VE, PC, PE, VF
	EH0936	Gasket, Valve, 0.500, PTFE	6	46	FC
*15	EH0028	O-Ring, P12 FKM	3	31,36,46	VC, PC
	EH0051	O-Ring, P12 EPDM	3	31,36,46	VE, PE, VF
	EH0939	Gasket, Adapter, PTFE	2	31,36,46	FC
*17	EH0122	O-Ring, P16 FKM	2	31, 36	VC, PC
	EH0127	O-Ring, P16 EPDM	2	31, 36	VE, PE, VF
	EH0650	O-Ring, 24 x 2.62, FKM	2	46	VC, PC
	EH0649	O-Ring, 24 x 2.62 EPDM	2	46	VE, PE, VF
	EH0365	Gasket, Housing, PTFE	2	31, 36	FC
	EH0941	Gasket, Housing, PTFE	2	46	FC
19	EH2106	Bolt, M5 x 40 316 SS	4/6	31,36,46	All
20	EH2011	Washer, M5 Flat, 316 SS	0	31,36,46	All
21	EH2012	Washer, M5 Lock, 316 SS	0	31,36,46	All
*22	EH0302	O-Ring, Knob, Seal	1	31,36,46	VC, PC
	EH0303	O-Ring, Knob, Seal	1	31,36,46	VE, PE, VF
*23	EH0300	O-Ring, Knob, Stop	1	31,36,46	VC, PC
	EH0301	O-Ring, Knob, Stop	1	30,36,45	VE, PE, VF
*24	EH1082	O-Ring, Fitting Seal	1	31, 36	VC, PC
	EH1084	O-Ring, Fitting Seal	1	31, 36	VE, PE, VF
	EH0122	O-Ring, Fitting Seal	1	46	VC, PC
	EH0127	O-Ring, Fitting Seal	1	46	VE, PE, VF
25	EH0299	Adjustment Knob	1	31,36,46	VC, VE, VF
	EH0321	Adjustment Knob	1	31,36,46	PC, PE
26	EH1662	Manual Air Vent Valve Body	1	31,36,46	VC, VE, VF
	EH1665	Manual Air Vent Valve Body	1	31,36,46	PC, PE
27	EH1078	Valve Housing MAVV	1	31, 36	VC, VE, VF
	EH1088	Valve Housing MAVV	1	31, 36	PC, PE
	EH1660	Valve Housing MAVV	1	46	VC, VE, VF
	EH1663	Valve Housing MAVV	1	46	PC, PE
28	EH1674	Lock Nut, MAVV	1	31, 36	VC, VE, VF
	EH1675	Lock Nut, MAVV	1	31, 36	PC, PE
	EH1661	Lock Nut, MAVV	1	46	VC, VE, VF
	EH1664	Lock Nut, MAVV	1	46	PC, PE
31	EH0653	Spacer, V.Housing, PVC	2	46	VC, VE, VF
	EH0683	Spacer, V.Housing, PP	2	46	PC, PE
	EH0940	Spacer, V.Housing, PVDF	2	46	FC
ZZ	-----	Brass Spacers			Drive specific/Re-use when replacing the diaphragm

* Included in spare parts kit

5.4 EHE 56 Liquid End Exploded View

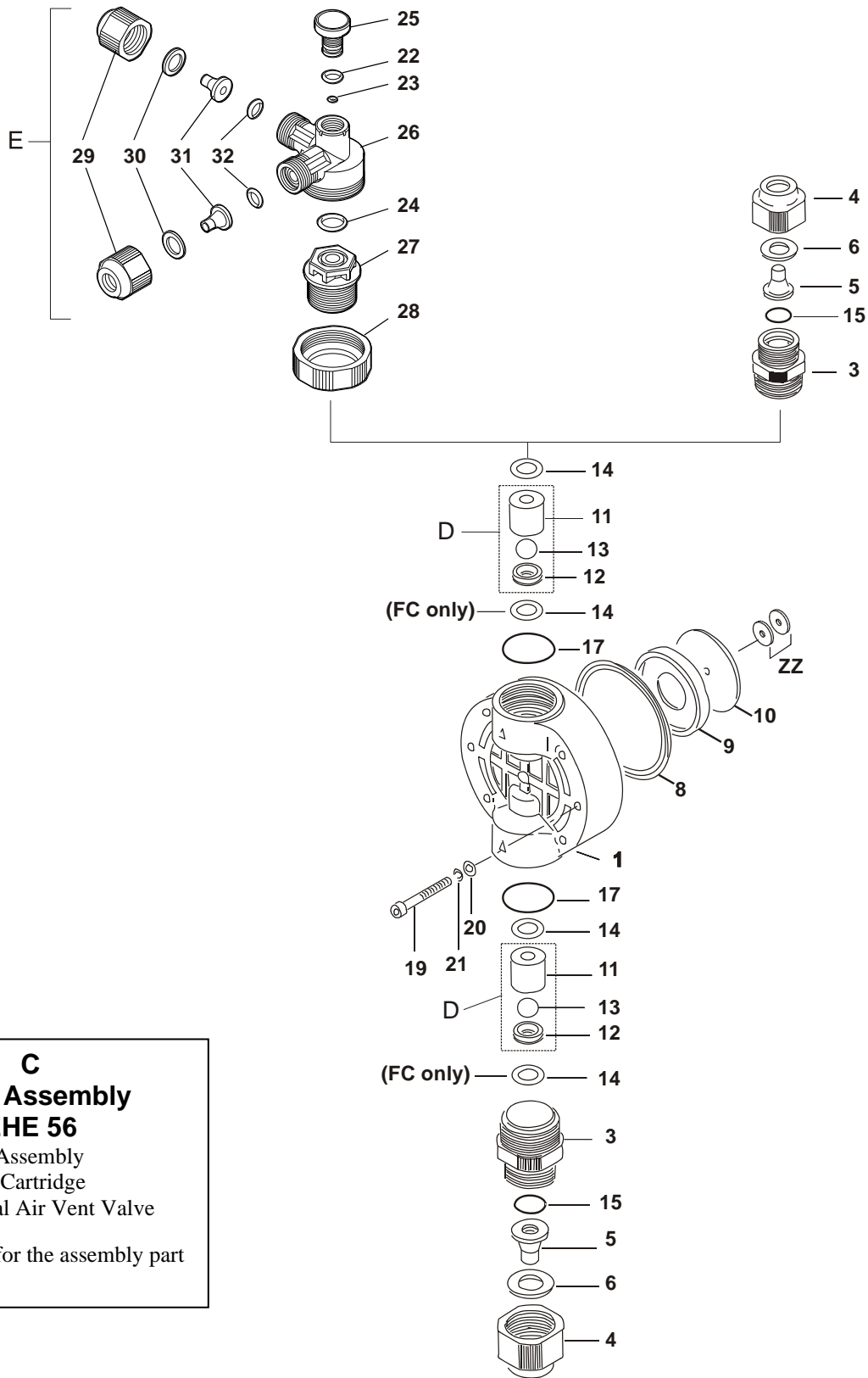

C
Head Assembly
EHE 56

C Head Assembly
D Valve Cartridge
E Manual Air Vent Valve

See page 31 for the assembly part numbers

EHE 56 Liquid End Parts List

Item	Part No	Description	Qty	Size	Liquid End Material
1	EH2114	Head, E56 PVC	1	56	VC, VE, VF
	EH2115	Head, E56 GFRPP	1	56	PC, PE
	EH2118	Head, E56 PVC Machined	1	56	VM
	EH2116	Head, E56 PVDF	1	56	FC
3	EH0656	Housing, Valve, E56, PVC	1	56	VC, VE, VM, VF
	EH0685	Housing, Valve, E56, GFRPP	1	56	PC, PE
	EH0916	Housing, Valve, ½ PVDF	2	56	FC
4	EH0657	Nut, Coupling, E56, PVC	1	56	VC, VE, VM, VF
	EH0686	Nut, Coupling, E56, GFRPP	1	56	PC, PE
	EH0917	Nut, Coupling, E56, PVDF	2	56	FC
5	EH0730	Adapter, E56, 1/2, PVC	1	56	VC, VE, VM, VF
	EH0736	Adapter, E56, 1/2, GFRPP	1	56	PC, PE
	EH0923	Adapter, E56, PVDF	2	56	FC
6	EH0731	Clamp Ring, E56, 1/2, SS	1 (2)	56	All (FC)
*8	EH2119	Diaphragm, PTFE/EPDM	1	56	All
*9	EH0660	Retainer, Secondary, PPS	1	56	All
*10	EH0659	Retainer	1	56	All
*11	EH0661	Guide, Valve, .625, PVC	2	56	VC, VE, VM, VF
	EH0718	Guide, Valve, .625, GFRPP	2	56	PC, PE
	EH0918	Guide, Valve, 0.625, PVDF	2	56	FC
*12	EH2242	Seat, Valve, .625, FKM	2	56	VC, VM, PC
	EH0663	Seat, Valve, .625, EPDM	2	56	VE, PE, VF
	EH0920	Seat, Valve, 0.625, PCTFE	2	56	FC
*13	EH0664	Ball, Valve, .625, CE	2	56	VC, VE, VM, PC, PE, FC
	E00073	Ball, Valve, .625, PTFE	2	56	VF
*14	EH0666	Gasket, Valve, .625, PTFE	2	56	VC, VE, VM, PC, PE, VF
	EH0921	Gasket, Valve, 0.625 PTFE	4	56	FC
*15	EH0122	O-Ring, P16 FKM	1	56	VC, VM, PC
	EH0127	O-Ring, P16 EPDM	1	56	VE, PE, VF
	EH0924	Gasket, Adapter, PTFE	2	56	FC
*17	EH0667	O-Ring, 29.8 X 2.62, FKM	2	56	VC, VM, PC
	EH0668	O-Ring, 29.8 X 2.62, EPDM	2	56	VE, PE, VF
	EH0925	Gasket, Housing, PTFE	2	56	FC
19	EH2054	Bolt, M5 x 55 SHC, 316 SS	6	56	VC, VE, PC, PE, VF
	EH2121	Bolt, M5 x 75 SHC, 316 SS	6	56	VM
20	EH2011	Washer, M5 Flat, 316 SS	6	56	All
21	EH2012	Washer, M5 Lock, 316 SS	6	56	All
*22	EH0302	O-Ring, Knob, Seal	1	56	VC, PC
	EH0303	O-Ring, Knob, Seal	1	56	VE, PE, VF
*23	EH0300	O-Ring, Knob, Stop	1	56	VC, PC
	EH0301	O-Ring, Knob, Stop	1	56	VE, PE, VF
*24	EH0122	O-Ring, Fitting Seal	1	56	VC, PC
	EH0127	O-Ring, Fitting Seal	1	56	VE, PE, VF
25	EH0299	Adjustment Knob	1	56	VC, VE, VF
	EH0321	Adjustment Knob	1	56	PC, PE
26	EH1662	Manual Air Vent Valve Body	1	56	VC, VE, VF
	EH1665	Manual Air Vent Valve Body	1	56	PC, PE
27	EH1666	Valve Housing MAVV	1	56	VC, VE, VF
	EH1667	Valve Housing MAVV	1	56	PC, PE
28	EH1661	Lock Nut, MAVV	1	56	VC, VE, VF
	EH1664	Lock Nut, MAVV	1	56	PC, PE
29	EH0620	Coupling Nut	2	56	VC, VE, VF
	EH0676	Coupling Nut	2	56	PC, PE
30	EH0720	Clamp Ring	2	56	VC, VE, PC, PE, VF
31	EH0719	Adapter	2	56	VC, VE, VF
	EH0734	Adapter	2	56	PC, PE
32	EH0028	O-Ring, Coupling Nut	2	56	VC, PC
	EH0051	O-Ring, Coupling Nut	2	56	VE, PE, VF
ZZ	-----	Brass Spacers	Drive specific/ re-use when replacing diaphragm		
*	Included in spare parts kit				

5.5 EHE-HV Liquid End Parts List

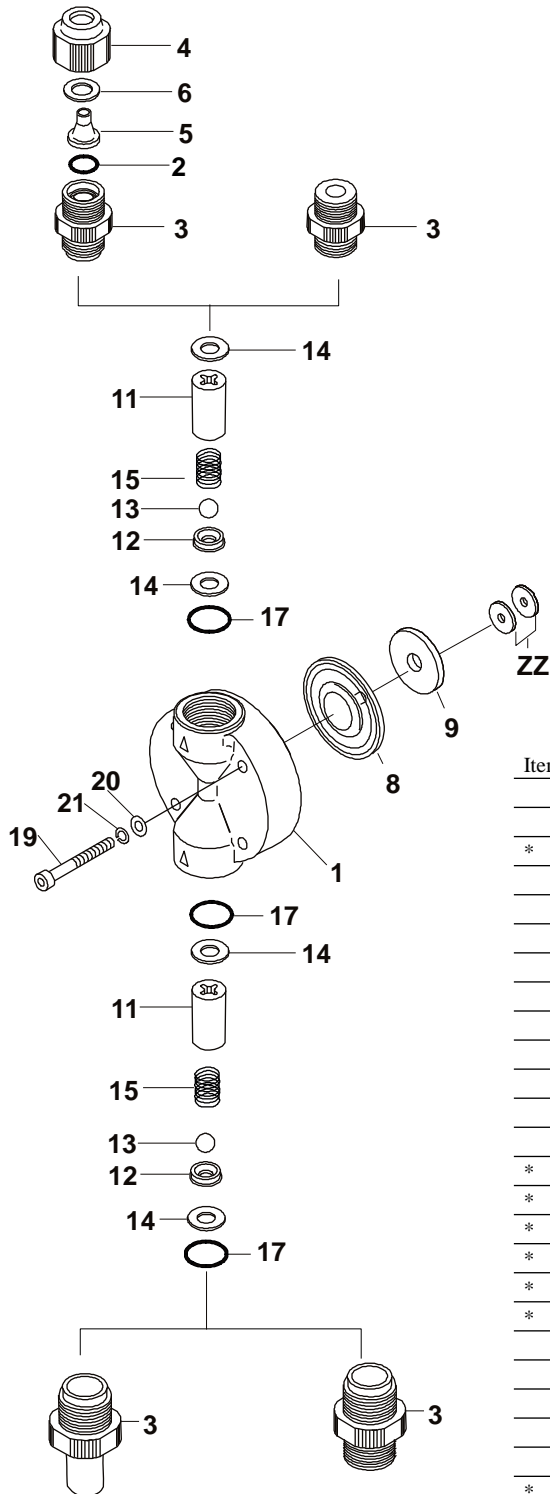

Item	Part No	Description	Qty	Size	Liquid End	
1	EH2392	Head, HV, GFRPP	1	36	All	
	EH2110	Head, HV, GFRPP	1	46	All	
*	2	EH0028	O-Ring, P12, FKM	1	36,46	HV, HVV
	3	EH1244	Housing, Valve, 1/2" NPT, PVC	2	36,46	HVT, HVP
	EH0679	Housing, Valve, 1/2" Tube, GFRPP	1	36,46	HV, HVV	
	EH1297	Housing, Valve, Suction, GFRPP	1	36,46	HV, HVV	
	4	EH0676	Nut, Coupling, GFRPP	1	36,46	HV, HVV
	5	EH0734	Adapter, Tubing, 1/2 GFRPP	1	36,46	HV, HVV
	6	EH0720	Clamp ring, tubing, 1/2 SS	1	36,46	HV, HVV
	8	EH2108	Diaphragm, PTFE/EPDM	1	36	All
	EH2113	Diaphragm, PTFE/EPDM	1	46	All	
	9	EH0637	Retainer, Diaphragm	1	36	All
	EH0642	Retainer, Diaphragm	1	46	All	
*	11	EH1295	Guide, Valve, .500, GFRPP	2	36,46	All
*	12	EH1247	Seat, Valve, 0.500, PCTFE	2	36,46	All
*	13	EH0647	Ball, Valve, 0.500, 316 SS	2	36,46	All
*	14	EH0936	Gasket, Valve, 0.500, PTFE	4	36,46	All
*	15	EH1291	Spring, Valve, HC	2	36,46	All
*	17	EH0650	O-Ring, 24 x 2.62, FKM	2	36,46	All
	19	EH0487	Bolt, M5 x 38 SHC, 304SS	4	36	All
	EH2054	Bolt, M5 x 55 SHC, 316SS	6	46	All	
	20	EH2011	Washer, M5 Flat, 316SS	6	46	All
	21	EH2012	Washer, M5 Lock, 316SS	6	46	All
	ZZ	-----	Spacers, Brass		Re-use	

* Included in spare parts kit

5.6 Drive Control Components

Item	Part No.	Description	Qty
31	EH1746	Base, Pump, EHE	1
32	EH0697	Cover, Control Panel	1
33	EH1658	Gasket, EHE Pump Base	1
34	EH1071	Screw, M5 x 15, SS, PH	4
35	EH0696	Gasket, Control/Drive Unit	1
36	EH0202	Grommet, Cord	3
37	EH0205	Nut, Strain Relief	3
38	EH0204	Cap, Strain Relief	2
39	EH0706	Box, Terminal, EHE	1
40	EH1036	Gasket, Terminal Box	1
41	EH0710	Screw, M3 x 50, SS, PH	1
42	EH0711	Screw, 5-10 SS PH Self Tap	2
43	EH0261	Gasket, M3 x 5 Bolt	1
44	EH1037	Screw, M3.5 x 10, SS, PH	2
45	EH1038	Screw, M3.5 x 25, SS, PH	2
46	EH0872	Gasket, Stroke Adjustment	1
47	EH0871	Knob, Stroke length Adj.	1
48	EH0873	Screw, M4 x 30 SS PH	1
49	EH0141	Cap, Stroke Length Adj Knob	1

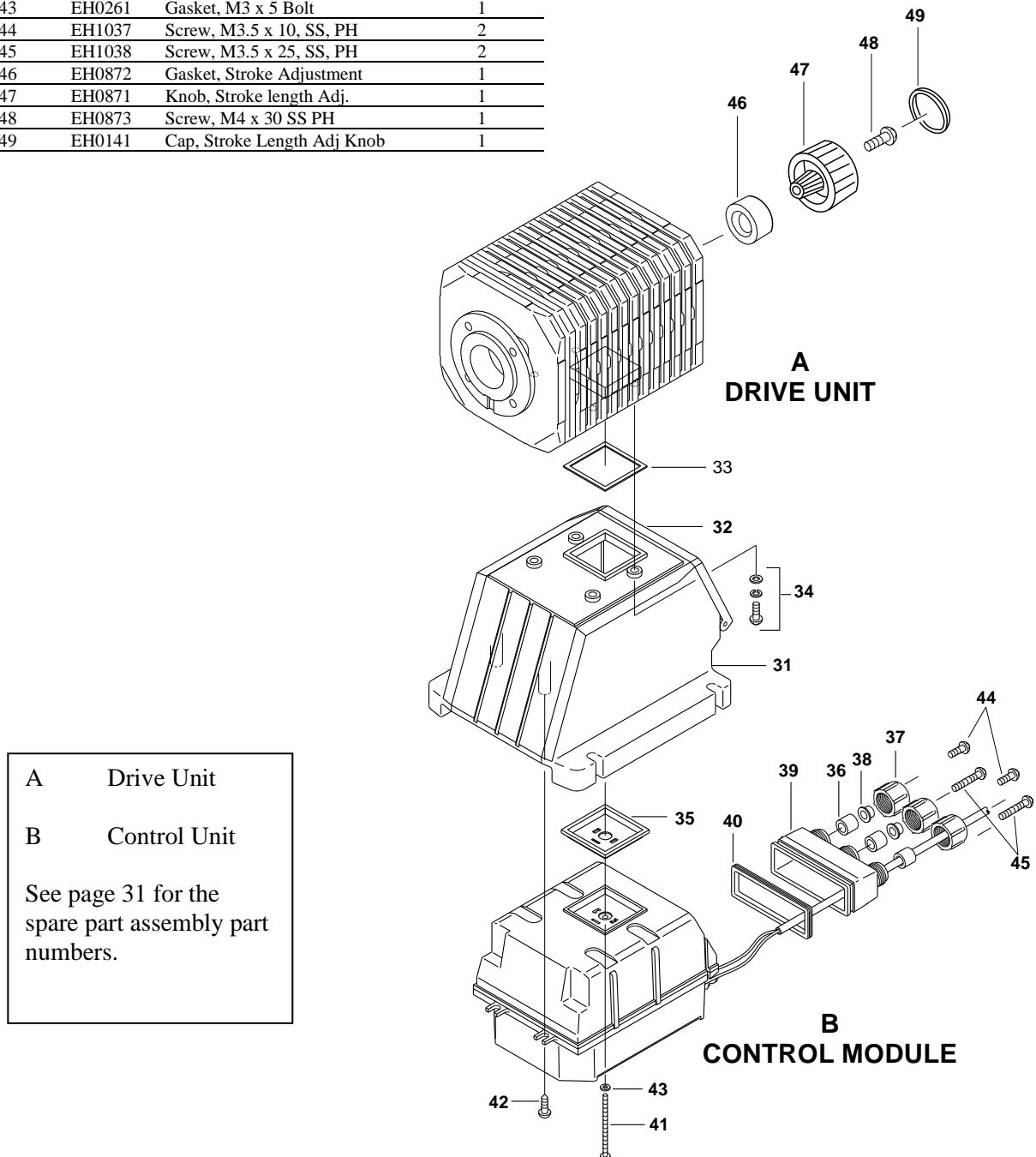

5.7 Assembly Part Numbers

Key letter from exploded view drawing, previous pages

- A Drive Unit
- B Control Module
- C Head Assembly
- D Valve Cartridge
- E Manual Air Vent Valve Assembly



Pump Model	Drive Unit Use P/N:	Control Module Use P/N:	<div style="border: 1px solid black; display: inline-block; padding: 2px;">C</div> Head Assembly Liquid End Code							
			VC	VE	VF	PC	PE	VM	FC	HV
			EHE31E1-	HE31-1	EHC-E11UPE (115V)	E31VC	E31VE	E31VF	E31PC	E31PE
EHE31E2-	HE31-2	EHC-E23UPE (230V)								
EHE36E1-	HE36-1	EHC-E11UPE (115V)	E36VC	E36VE	E36VF	E36PC	E36PE	--	E36FC	--
EHE36E2-	HE36-2	EHC-E23UPE (230V)								
EHE46E1-	HE46-1	EHC-E11UPE (115V)	E46VC	E46VE	E46VF	E46PC	E46PE	--	E46FC	--
EHE46E2-	HE46-2	EHC-E23UPE (230V)								
EHE56E1-	HE56-1	EHC-E11UPE (115V)	E56VC	E56VE	E56VF	E56PC	E56PE	E56VM	E56FC	--
EHE56E2-	HE56-2	EHC-E23UPE (230V)								
EHE36E1-	HE36-1	EHC-E11UPE-HV (115V)	--	--	--	--	--	--	--	E36HV
EHE36E2-	HE36-2	EHC-E23UPE-HV (230V)								
EHE46E1-	HE46-1	EHC-E11UPE-HV (115V)	--	--	--	--	--	--	--	E46HV
EHE46E2-	HE46-2	EHC-E23UPE-HV (230V)								
<div style="border: 1px solid black; display: inline-block; padding: 2px;">D</div> Valve Cartridge		31, 36	E90052	E90071	E90313	E90055	E90073	--	E90316	--
		46	E90074	E90075	E90314	E90077	E90078	--	E90317	--
		56	E90079	E90080	E90315	E90082	E90083	E90079	E90318	--
<div style="border: 1px solid black; display: inline-block; padding: 2px;">E</div> Manual Air Vent Valve Assembly		31, 36	E90589	E90590	E90590	E90591	E90592	--	--	--
		46	E90366	E90367	E90367	E90368	E90369	--	--	--
		56	E90370	E90371	E90371	E90372	E90373	E90370	--	--

5.8 Spare Parts Kit

The spare parts kit number is the Head Assembly part number with ‘-PK’ at the end. (E31VC-PK, E31VE-PK, E31PC-PK, etc.)

Spare parts kit includes: diaphragm, retainer(s), valve guides, valve seats, valve balls, valve gaskets, o-rings and a hex wrench (head bolts are not included) (see the exploded view drawings for detail of parts in the spare parts kits)

6.0 TROUBLESHOOTING



Caution: Before working on the pump disconnect the power cord, depressurize the discharge tubing and drain or flush any residual liquid from the pump head and valves.

Problem	Possible Cause	Corrective Action
<i>Pump does not start</i>	Faulty wiring	Correct wiring
	Improper voltage	Connect to proper voltage source
	Electronic control unit is damaged	Replace control unit (Contact distributor or factory)
<i>Pump does not prime</i>	Pump stroke length is too short	Operate pump with stroke length set at 100% until primed. Then set the stroke length as needed to obtain desired output.
	Air in suction tubing	Reroute suction tubing to eliminate air trap
	Valve gasket is missing	Install valve gasket
	Valve set assembly direction is wrong.	Reassemble valve set
	Pump is air locked	Prime pump per instructions
<i>Output fluctuates</i>	Suction or discharge valve is clogged with foreign matter	Disassemble, inspect, clean
	Air is trapped in pump	Prime pump per instructions
	Overfeeding	Install injection valve or back pressure valve. Check stroke length knob(@ 0%, pump should not pump)
	Diaphragm is damaged	Replace diaphragm
	Worn check valves	Replace valve cartridges
<i>Liquid leaks</i>	Fitting or coupling nut is loose	Tighten
	Pump head is loose	Tighten pump head bolts. Torque: 19 lb-in (2.16 N-m)
	Diaphragm is damaged	Replace diaphragm
	O-ring or valve gasket missing.	Install o-ring or valve gasket

7.0 SERVICE POLICY

The EHE Series electronic metering pumps have a 2-year warranty. Contact your Walchem distributor for service.

FIVE BOYNTON ROAD
TEL: 508-429-1110

HOPPING BROOK PARK

HOLLISTON, MA 01746 USA
Web: www.walchem.com